

## 2G4 Deployment and demonstration Tool

*User guide version 1.0*

1. The suitcase with the 2G4 deployment and demonstration tool is used for two purposes: sales presentation as well as testing when measuring the system's area of coverage. You will find all the necessary units in the suitcase when using the kit for demonstration and deployment. You will have the possibility to present subscription and cancellation of the handset and establish a conversation between the two handsets. When the deployment and demonstration tool is delivered both of the enclosed handsets is subscribed. If the handsets have been cancelled subsequently you must subscribe them again before using the system. Subscription procedure is described later in this user guide.
2. Before setting up the kit you have to ensure that the suitcase contains all necessary parts. The suitcase contains:
  - 1 Base station
  - 2 Handsets
  - 2 Handset desk chargers
  - 1 Handset user guide
  - 1 Audio Cable
  - 1 Headset
  - 1 Battery pack for the base station
  - 1 CD player
  - 1 User guide (this guide)
  - 2 Mains adapter for the handsets
  - 1 Mains adapter for the base station
  - 1 Mains adapter for the battery pack

Before using the handset it is of great importance that you charge the batteries completely. For information regarding charging the handsets, please see the handset user guide.
3. If using the base station for presentation purpose it will only be necessary to connect the power supply. Having the base station used for measuring the area of coverage it would be desirable to connect

an audio signal from the CD player and the battery pack for easy moving of the base station.

Connections to the base station and registration button are shown in figure 1.

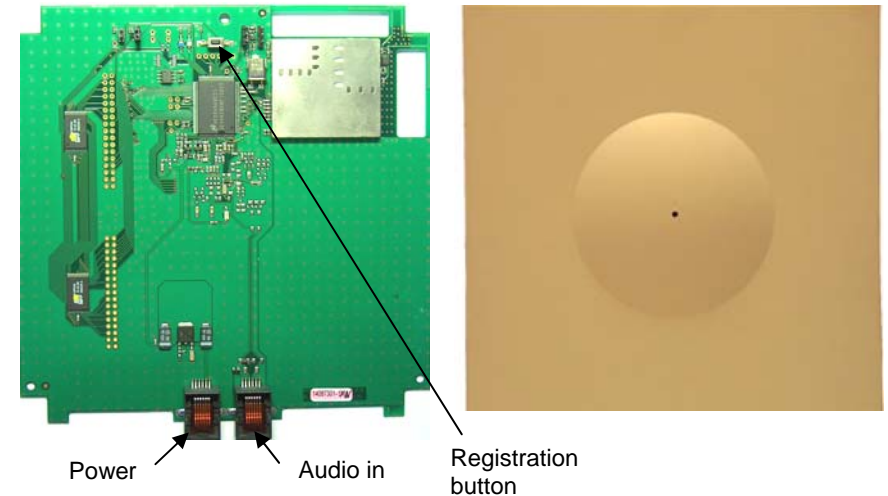

To operate the kit it is not necessary to remove the cover as shown in figure 1. Only if the handsets are, for some reason, unsubscribed from the base station, it will be necessary to push the registration button as shown on fig. 1.

### **Power supply**

The base station is supplied by a 9V/300mA adaptor. Current consumption is max. 130mA. It is connected to the plug at the bottom of the base station (see fig. 1).

### **Audio signal input**

The audio signal input is the audio signal from the provided CD player. The signal is forwarded to a handset on off-hook.

### **Registration button**

If pressed for 3 sec. the base station will send out its PARK code for 1 minute and subscription will be allowed within this period by giving

the right AC key (AC = last four digits of the base serial number). For further information concerning registration, please refer to section 6.1. Please note that the handsets are registered to the base from the factory.

4. Operation of the basic function of the handset is described in the enclosed handset user guide.  
Using the kit it is possible to make calls between handsets.

- Press "INT" and you will hear the dialing tone
- Press the number of the other handset (1-8)

5. In order to find the best place for the base stations in the system, the kit is used for measuring the area of coverage of one base station within the building in question.

Start placing the base station at the most desirable place. See fig. 2 and fig. 5.

After having placed the base station, you measure the area of coverage. If the test is unsatisfactory you choose another place and re-start the testing.

6. Place the base station in the wanted area. Connect the base station to the power supply and the audio source. If the handset is not subscribed to the base station, please refer to the relevant paragraph.

If the handset is subscribed it is possible to have information about which base station the handset has been subscribed to and how well the strength and quality of the signal is. For this purpose is used the so-called RSSI menu (Receiving Strength Signal Indication).

Press: **\*99989\* ENTER**

The RSSI menu is shown in the display with information as follows: see fig. 3.

### 6.1 Subscription of handset

The handsets are subscribed to the base station from the factory. If the handsets are not subscribed to the base station follow these instructions:

- Connect the base station to the electric supply
- Switch on the handset
- Press **\*99972\*x** where x corresponds to the wanted handset number (1 – 8)

Press **OK**

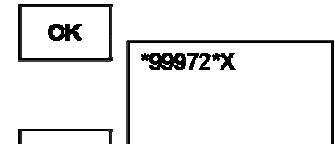

Press **MENU**

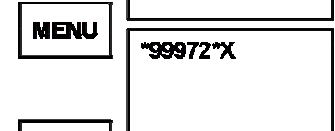

Press **OK**

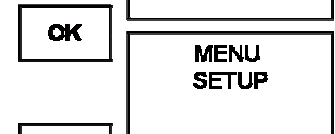

Press **<** three times

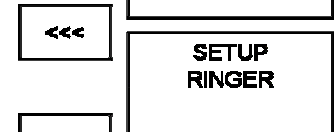

Press **OK**

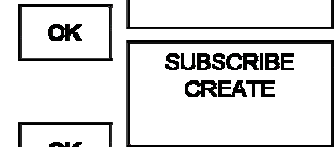

Press **OK**



The handset is now searching for the systems allowing subscription.

Press the registration button of the base station for 3 seconds. The base station sends out its park number for 1 minute to

allow subscription. In case there are other systems in the area use the < and > keys for scrolling between the systems IDs. When the system ID (written on the back of the base station) is found, press **OK**

The display shows:

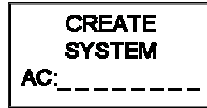

When you select which one of the four different subscription memories this particular handset may be subscribed to you use the < and > keys.

Press the AC key (AC = the last four digits of the base station serial number).

Then press **OK**

If subscription was successful the radio signal symbol (📶) appears in the display, meaning that the handset is subscribed. The symbol is shown as long as the handset is subscribed to a system and there is radio contact.

**Attention!** A short press on the registration button of the base station will start a broadcast ringing on the handset connected to the base station, and the indicator LED will flash quickly.

## **Safety Instructions –**

### **Important Safety Instructions and Product Information**

Before using your telephone equipment, you should always follow basic safety instruction to reduce the risk of fire, electrical shock and injury to persons, and damage to property.

1. Read and understand all instructions
2. Follow all warnings and instructions including those marked on the product
3. Unplug this product before cleaning. Do not use liquid cleaners or aerosol cleaners. Use damp cloth for cleaning
4. Do not install the telephone equipment in the bathroom or near a wash bowl, kitchen sink, or laundry tub, in a wet basement, or near a swimming pool
5. Slots or openings in the cabinet back and bottom of the equipment are provided for ventilation to protect it from over-heating. These openings must not be blocked or covered
6. The product should be operated only from the type of power source indicated on the instructions. If you are not sure of the type of power supply, consult your dealer or local power company
7. Do not overload wall outlets and extension cords as this can result in fire or electrical shock
8. Never push objects of any kind into this product through cabinet slots as they may touch dangerous voltage points or short out parts that could result in fire, electrical shock, or injury. Never spill liquid of any kind into this product
9. To reduce the risk of electrical shock or burns, do not disassemble this product. Opening or removing covers may expose you to dangerous voltages, dangerous electrical current, or other risks. Incorrect reassemble can cause electrical shock when the appliance is subsequently used. If the product need repair, consult your dealer
10. Refer servicing to qualified service personnel under the following conditions:
  - AQ If liquid has been spilled into the product
  - BQ If the product has been exposed to rain or water
  - CQ If the product does not operate normally when following the operating instructions in the manual. Adjust only those controls that are covered by the operation instructions. Improper adjustment of other controls may result in damage and will often require extensive work by qualified service personnel to restore the product to normal operation
  - DQ If the product has been dropped or cabinet has been damaged

EQ If the product exhibits a distinct change in performance

11. Avoid using telephone during an electrical storm. There may be a risk of electrical shock from lightning
12. Do not use the telephone to report a gas leak in the vicinity of the leak
13. Do not place the base or charger near microwave ovens, radio equipment, or non-ground connected televisions. These appliances may cause electrical interference to the base or handset
14. The charger must be placed on a hard, flat surface and connected to a functional 120 volt AC power net adapter and plug the adapter into the power outlet
15. This telephone will not operate in the event of a blackout. Please keep a backup phone for emergencies

#### **Intrinsic safety**

Do not use the handset in conditions where there is a danger of electrically ignited explosions

#### **Exposure to sunlight, heat and moisture**

Do not expose the cordless phone to direct sunlight for long periods. Keep the cordless phone away from excessive heat and moisture

#### **Battery disposal**

Defective batteries must be returned to a collection point for chemical waste disposal

#### **Spare parts and accessories**

Use only approved spare parts and accessories. The operation of non-approved parts cannot be guaranteed and may even cause damage

#### **Power failure**

In the event of a power failure or flat battery, you cannot use the handset to make or receive calls

**NOTICE:** Before installing this equipment, user's should ensure that it is permissible to be connected to the facilities of the local telecommunications company. The equipment must also be installed using an acceptable method of connection. The customer should be aware that compliance with the above conditions may not prevent degradation of service in some situations.

Repairs to certified equipment should be coordinated by a representative designated by the supplier. Any repairs or alterations made by the user to this equipment, or equipment malfunctions, may give the telecommunications company cause to request the user to disconnect the equipment. User's should ensure for their own protection that the electrical ground connections of the power utility, telephone lines and internal metallic water pipe system, if present, are connected together. This precaution may be particularly important in rural areas.

**CAUTIONS:** User's should not attempt to make such connections themselves, but should contact the appropriate electric inspection authority, or electrician, as appropriate. If your telephone equipment causes harm to the telephone network, the telephone company may ask you to disconnect the system from the line until the problem has been corrected or they may discontinue your service temporarily. If possible, they will

notify you in advance, but if advance notice is not practical, you should be notified as soon as possible.

Your telephone company may make changes in its facilities, equipment, operations, or procedures that could affect the proper functioning of your telephone system. If they do and it is possible, you will be notified in advance to give you an opportunity to maintain uninterrupted telephone service. If you experience trouble with this telephone system, disconnect it from the network until the problem has been corrected or until you are sure that the equipment is not malfunctioning.

**Note:** This equipment generates, uses and can radiate radio frequency energy and, if not installed and used in accordance with the instructions, may cause harmful interference to radio communications. However, there is no guarantee that interference will not occur in a particular installation. If this equipment does cause harmful interference to radio or television reception, which can be determined by turning the equipment off and on, the user is encouraged to try to correct the interference by one or more of the following measures:

- Reorient or relocate the receiving antenna

- Increase the separation between the equipment and receiver
- Connect the equipment into an outlet on a circuit different from that to which the receiver is connected
- Consult the dealer or an experienced radio/TV technician for help

**Power Outage:** In the event of a power outage, your cordless telephone will not operate. The cordless telephone requires electricity for operation. You should have a telephone which does not require electricity available for use during power outages.

**Information to user:** The user's manual or instruction manual for an intentional or unintentional radiator shall caution the user that changes or modifications not expressly approved by the party responsible for compliance could void the user's authority to operate the equipment.

#### **LIMITED WARRANTY**

This limited, non-transferable warranty is provided to the original purchaser. The product is warranted to be free from defects in materials and workmanship under normal installation, use and service for a period of one (1) year from the date of purchase as shown on the purchaser's receipt. Our obligation under this warranty is limited to repair or replacement (at our option) of the product or any part(s) which are defective provided that the product is returned to the original place of purchase or an authorized service location during the warranty period. Products returned must be accompanied by a copy of the purchase receipt. In the absence of a purchase receipt, the warranty period shall be one (1) year from the date of manufacture. Repair or replacement of the product is your sole and exclusive remedy. If the product is repaired, reconditioned component parts or materials may be used. The repaired product will be warranted for either (a) 90 days or (b) the remainder of the original one (1) year warranty period, whichever is longer. This warranty does not apply to the defects outside of our control, including but not limited to acts of God, fire, flood and damage while in transit to service facility. We do not warranty that the product will be compatible with any telephone equipment, systems or party lines. This warranty shall be void if the product is damaged as a result of defacement, misuse, abuse, neglect, accident, destruction or alteration of the serial number, improper electrical voltages or currents, repair, alteration or maintenance by any person or party other than our authorized service facility, or any violation of instructions furnished by us. This warranty is also void if this product is removed from the country in which it was purchased by the original purchaser, if it is used in a country in which it is not registered for use, or if it is used in a country for which it

was not designed. Due to variations in telephone systems and communications laws, this product may be illegal for use in some countries. We assume no responsibilities for damages or penalties incurred resulting from the use of this product in a manner or location other than that for which it was intended.

THIS LIMITED WARRANTY IS IN LIEU OF ALL OTHER WARRANTIES EXPRESS OR IMPLIED. ANY IMPLIED WARRANTIES INCLUDING BUT NOT LIMITED TO THE IMPLIED WARRANTIES OF MERCHANTABILITY AND FITNESS FOR A PARTICULAR PURPOSE, SHALL BE LIMITED TO THE DURATION OF THIS WRITTEN LIMITED WARRANTY. WE DISCLAIM ANY LIABILITY FOR DAMAGES FOR LOSS OF USE OF THE PRODUCTS, LOSS OF TIME, INCONVENIENCE, INJURY TO ANY PERSON, OR DAMAGE TO PROPERTY CAUSED BY THE PRODUCT, LOSS OF REVENUE OR PROFIT OR DAMAGES FOR ANY FAILURE TO PERFORM. IN NO EVENT SHALL WE BE LIABLE FOR ANY SPECIAL, INCIDENTAL, PUNITIVE OR CONSEQUENTIAL DAMAGES EVEN IF WE ARE ADVISED OF THE POSSIBILITY OF SUCH DAMAGES.

Some states do not allow limitations on how long an implied warranty lasts, so the above limitations may not apply to you. This warranty is the sole and exclusive warranty provided for the product. There are no other express warranties. This warranty gives you specific legal rights, and you may also have other rights, which vary from state to state.

## Guidelines for deployment

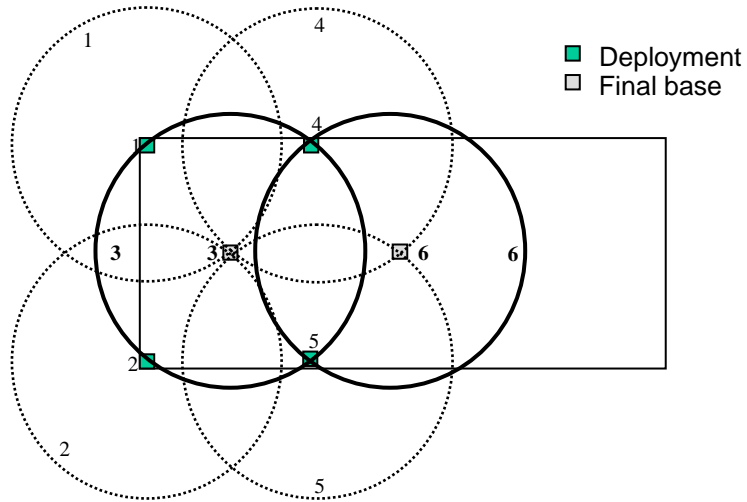

Fig.2

The deployment RFP is used for measuring the placing of the permanent RFP. The permanent RFP should be placed (position 3) in the position in which RSSI 65 is measured and a stable Q52 value, higher than 52, from the deployment RFP in position 1 and 2.

Then the deployment RFP is moved to position 4 and 5, the measuring procedure is repeated and the final RFP is placed in position 6.

If the system is to be expanded later on this can be done according to the same principles.

## RSSI menu

Code for test display: \*99989\* ENTER

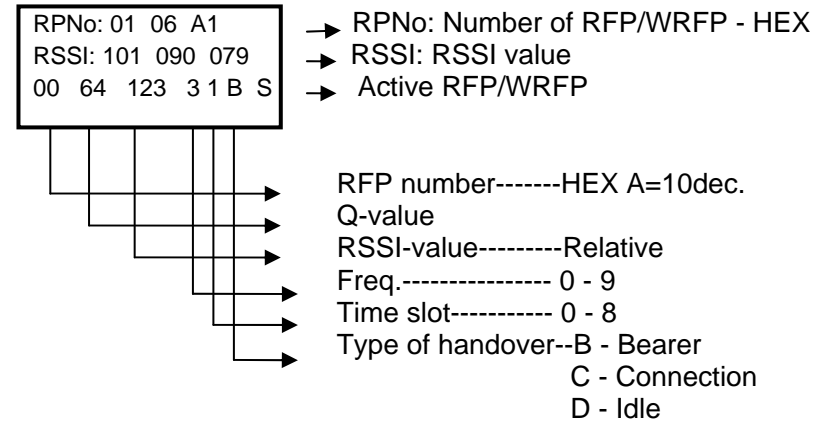

Fig. 3

Alternative base stations are listed according to RSSI values. Measuring radio coverage is done in OFF-HOOK mode.

## Placement in buildings

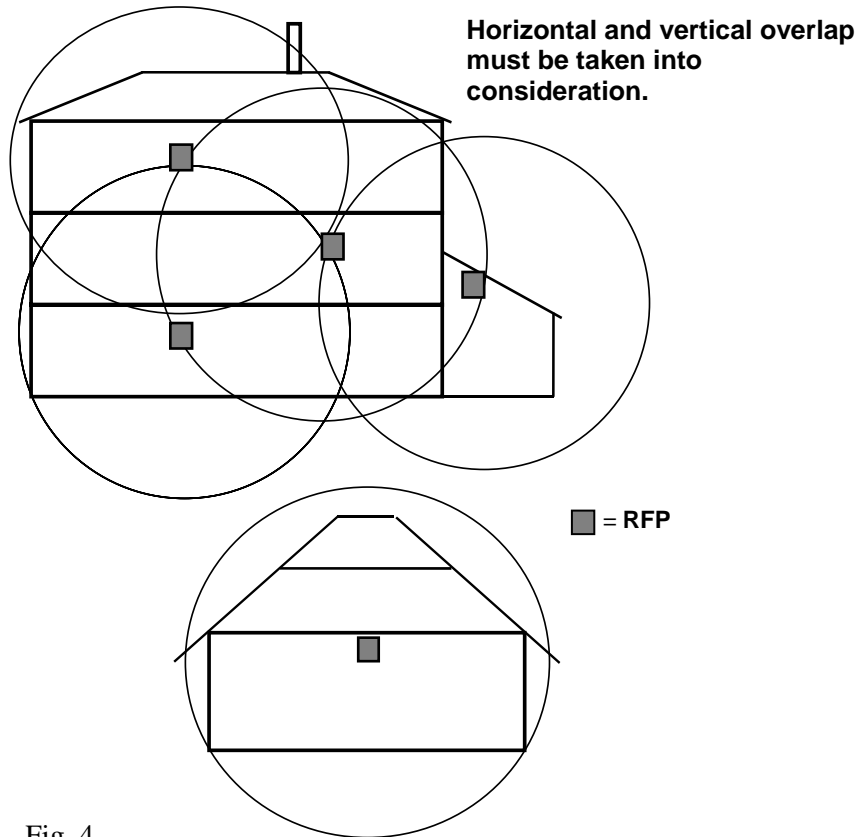

Fig. 4

### Explanation - Overlap

If overlap is not enough – less than 10 m – 15 m there is a risk of losing connection while moving from one area (radio coverage) to another. This is because the handset needs time to scan for an alternative base. If the alternative RFP/WRFP is not found while crossing overlap into another area, handover cannot take place and the connection to the system will be disconnected – ON-HOOK. This situation is similar to – Out of range.

The calculation regarding overlap is based on:  
 Walking speed = 3.5 km per hour  
 Scanning time = 10 sec.

$$\text{Overlap} = \frac{3500 \text{ m (walking speed)} \times 10 \text{ sec. (scanning time)}}{3600 \text{ (sec. per hour)}}$$

**Overlap between RFP's**  
 Recommended overlap: 10-15m (min.)

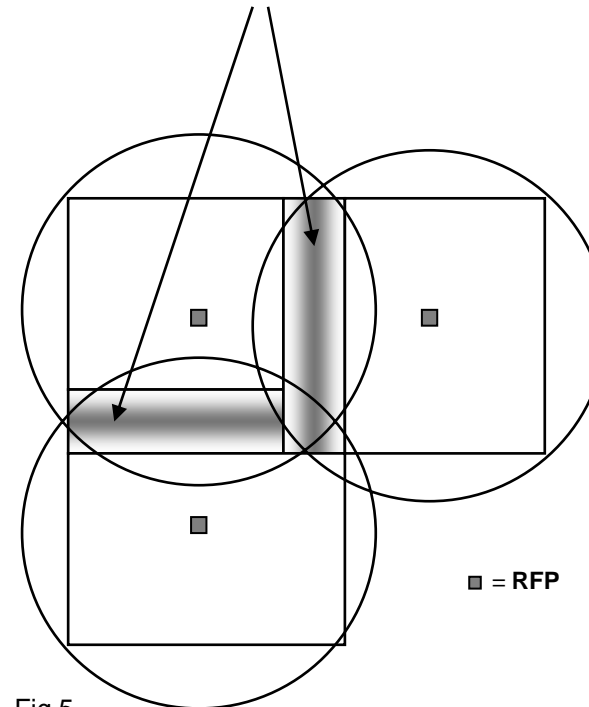

Fig 5

## **Radio coverage**

Measuring radio coverage can be done the following way:

Look at the Q-value and the RSSI-value while moving away from the RFP/WRFP. As soon as the Q-value goes down to 52 or the RSSI-value goes down to 65 the limit of the radio coverage has been reached.

During measurement of radio coverage it is important to simulate the influence of the human body. This can be done either by shielding the antenna by the hand or by turning the handset and the body in a way to achieve a “worst case” situation for reception of the radio signal from a given base station. In both situations it is important that the Q-value and the RSSI-value is stable and not fluctuating. Measuring radio coverage is done in Off-Hook mode.

### **Q-52**

The Q-value is a relative expression for the bit failure rate in the communication between the RFP and the handset. As soon as the Q-value goes down to 52 the handset will ask for handover to the alternative RFP.

### **RSSI**

The RSSI-value is a relative expression for the field strength – signal from the RFP. The RSSI-value is only used for the choice of the alternative RFP. The handset will choose the RFP in the area from which the strongest RSSI signal is received as the alternative RFP.

### **Shadows**

Be aware that “shadows” created by parts of the building can cause spots where no radio signals can be received at all.

### **Weather conditions and seasons of the year**

Different weather conditions may have influence regarding radio coverage. As soon part of the building gets wet, these parts can act as a shield.

Different seasons of the year can also have an influence regarding radio coverage. As soon as leaves on trees etc. are present, the radio coverage changes as a result of shielding created by growth of trees.