

norstar

Compact 616 DR5
Installer Guide

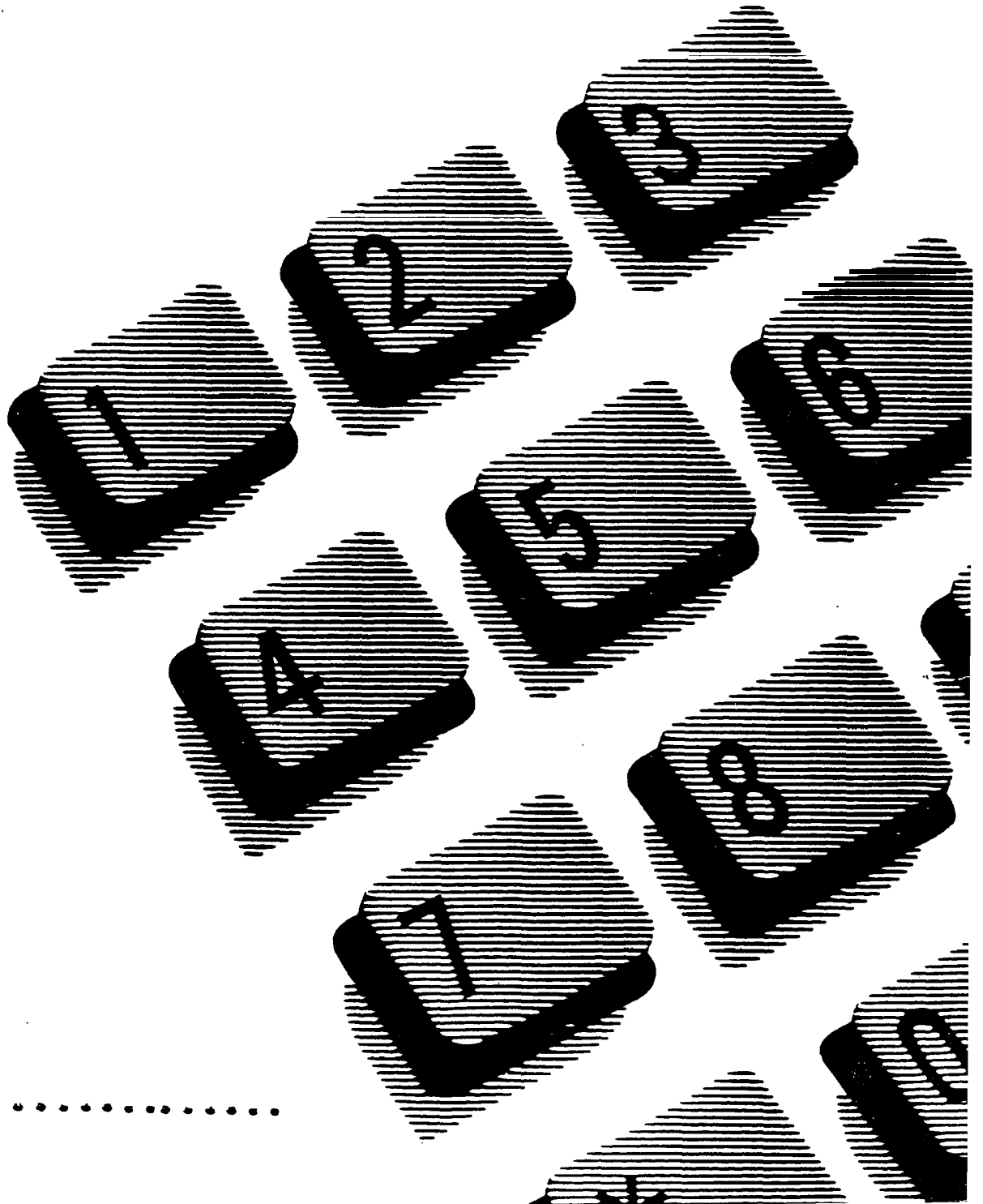

Regulations

Radio Frequency Interference

WARNING

This equipment generates, uses, and can radiate radio frequency energy. If not installed and used in accordance with the instruction manual, it may cause interference to radio communications. It has been tested and found to comply with the limits for a Class A computing device pursuant to Part 15 of the FCC **Rules**, which are designed to provide reasonable protection against such interference when operated in a commercial environment. Operation of this equipment in a residential area is likely to cause interference, in which case the user, at his own expense, will be required to take whatever measures may be required to correct the interference. Each **Norstar** Key Telephone System is assigned an FCC Registration Number and a Ringer Equivalence designation. The number and designation are printed on the Key Service Unit (KSU) label on the front of the unit inside the door.

Registration

The **Norstar** Key Telephone System is registered with the FCC based upon compliance with Part 68 of its rules. Connection of the **Norstar** Key Telephone System to the nationwide telecommunications network is made through a standard network interface jack that you can order from your telephone company. Jacks for this type of customer-provided equipment will not be provided on party lines or coin lines.

Interconnect

Norstar Compact equipment meets all applicable requirements of both the Canadian Department of Communications CS-03 and US Federal Commission FCC part 68 and has been registered under files DOC 3322492A and FCC **AB67UJ-17156-KF-E** (key system) and **AB67UJ-17338-MF-F** (Hybrid System)

Ringer Equivalence Number (REN) ____

The FCC Registration Label, on the inside of the door on the front of the Key Service Unit (KSU), **includes** the Ringer Equivalence Number (REN). This number shows the electrical load that your **Norstar** KSU requires from your telephone line. If the KSU requires more electrical current than your telephone company's central office equipment can provide, your telephones may not ring and you may have difficulty dialing telephone numbers.

Call the telephone company to find out the total REN allowed for your telephone line(s).

Hearing Aid Compatibility

Norstar telephones are **Hearing Aid** compatible, as defined in Section 68.316 of Part 68 FCC Rules.

Electromagnetic compatibility (EMC)

Radiated emissions

Norstar Compact equipment meets all FCC part 15, class A radiated emissions requirements.

Conducted emissions

Norstar Compact equipment meets all FCC part 15, class A - conducted emissions requirements.

Safety

Norstar Compact equipment meets all applicable requirements of both the Canadian Standards Association C22.2 No. 0.7 MI 985 and US Underwriter's Laboratory UL-1459, issue 1, and has been registered under files CSA **LR58855-12** and UL EI 15515 **88NK16650**.

Telephone Company Registration

It is usually **not** necessary to call the telephone company with information on the equipment before connecting the **Norstar** Key Telephone System Key Service Unit (KSU) to the telephone network but, if the telephone company requires this information, provide the following:

- Telephone number(s) to which the Key Service Unit (KSU) will be connected.
- FCC Registration Number (on label affixed to KSU, inside the door).
- Ringer Equivalence Number (on label affixed to KSU, inside the door).
- USOC Jack
RJ-21 X
- Service Order Code (SOC) 9.0 F
- Facility Interface Code
(FIC)02LS2

Use of a Music source

In accordance with U.S. Copyright Law, a license may be required from the American Society of Composers, Authors and Publishers, or similar organization if Radio or TV broadcasts are transmitted through the Music On Hold or Background Music features of this telecommunication system.

Northern Telecom Inc. hereby disclaims any liability arising out of the failure to obtain such a license.

This digital apparatus does not exceed the Class A limits for radio noise emissions from digital apparatus set out in the Radio Interference Regulations of the Canadian Department of Communications.

Rights of the **Telephone** Company

If the system is determined to be causing harm to the telephone network, the telephone company may discontinue your service temporarily. If possible, the telephone company will notify you in advance. If advance notice is not practical, you will be notified as soon as possible. You will be given the opportunity to correct the situation and you will be informed of your right to file a complaint to the FCC. Your telephone company may make changes in its facilities, equipment, operations or procedures that could affect the proper functioning of your system. If it does this, you will be notified in advance to give you the opportunity to maintain uninterrupted telephone service.

In the event of an equipment malfunction, all repairs will be performed by Northern Telecom Inc. or by one of its authorized dealers.

Address of a repair facility

USA

Northern Telecom Inc.
Product Service Center
640 **Massman** Drive
Nashville, TN
37210
Attn. **RA#** _____

Canada

Northern Telecom Canada Ltd.
Customer Service Dept. 914
12345 **Boul** Albert Hudon
Montréal-Nord, Québec
H1G 3L1

Contents

Preparation	1
Installing the KSU	3
External lines and internal wiring	4
Internal wiring chart	5
Installing the Emergency Telephone	6
Testing the Emergency Telephone	6
Installing the Norstar telephones	7
Installing a wall-mounted telephone	8
Installing optional equipment	9
Auxiliary Ringer (Customer Supplied)	9
External Music source (Customer Supplied)	9
External Paging (Customer Supplied)	10
Powering up the KSU	10
Programming	11
Programming overview	11
System Startup overview	16
Entering System Startup	17
Choosing the system template	18
Configuration Overview	19
Trk/Line Data	21
Line Access	24
Call Handling	27
Miscellaneous	30
System Data	33
Using Set Copy	38
Troubleshooting	39
Testing the lines and phones	39
Analog Terminal Adapter (ATA) trouble	40
Auxiliary Ringer trouble	40
Call Identification Interface	42
Dial tone absent (on external lines)	42
External Paging trouble	42
KSU down	43
Music on Hold/Background Music trouble	44
Telephone dead	44

Finishing up	45
Applying the button labels	45
For the customer	45
For the System Coordinator	45
In the KSU pocket	45
Personal programming	46
Call Display services	46

Preparation

Check the **location** where the **Norstar** system modules, the telephones, and auxiliary equipment are to be installed.

KSU Location requirements

- Clean, dry, and well-ventilated
- Temperature: 0°C to 50°C (32°F to 122°F)
- Humidity: 5% to 95%, non-condensing
- Location: at least 4 m (13.1 ft) from equipment such as photocopiers, electrical motors, and other equipment that can produce electromagnetic, radio frequency, and electrostatic interference.

Mounting requirements

If a smooth surface is not available, cut a backboard large enough to accommodate the system modules and the distribution panel.

Chart 1 — **KSU** dimensions and required clearances.

Dimension	Measurement	
Length	55.6 cm	(21.9 in)
Width	35.6 cm	(14 in)
Height	17 cm	(6.7 in)
Weight	5.25 kg	(11.6 lb)
Clearance (front)	1 m	(39.4 in)
Clearance (top)	30 cm	(11.8 in)
Clearance (bottom)	30 cm	(11.8 in)

Equipment for mounting the modules

- screwdriver, diagonal cutters, pliers, connecting tool, pencil, level (optional)
- three **5mm (#10)** wood screws, **38-mm (1 1/2-in)** long
- **19-mm (3/4-in)** thick wooden backboard (if necessary)

Internal wiring requirements

All new or existing wiring must meet the following specifications:

- one twisted pair per telephone
- a dc loop resistance less than **59 Ω**
- cable length (0.5 mm or 24 AWG) not to exceed 305 m (1000 ft)
- **use** of a **Norstar** Auxiliary Power Supply (SAPS) to extend the loop up to 790 m if the cable is longer than 305 m (1000 ft)
- no bridge taps

Electrical requirements

- Non-switched outlet
- ac outlet located not more than 1.5 m (4.9 ft) from the Key Service Unit (KSU).
- For 110V product: dedicated 110-V ac nominal, **50/60-Hz**, 15-A minimum service with third wire ground
- For 220V product: dedicated **220-** to 240-V ac nominal, **50/60-Hz**, 15-A minimum service with third wire ground

WARNING

The ac **outlet** must be equipped with a third wire ground to avoid electromagnetic interference.

Norstar as an OPX

Norstar can be used as an off premise extension (OPX) from a PBX. In order to support this application, the OPX lines must be engineered not to exceed **7 dB** total loop loss from the serving central **office** to the demarcation point at the **Norstar** KSU.

Installing the KSU

Note: Mount the KSU on a backboard with at least 10 cm (3.9 in) of clearance on its left-hand side, and at least 5 cm (2 in) of clearance on its right-hand side (viewed from the front of the KSU).

1. Unpack the KSU and inspect it for damage:
2. Before installing the KSU, open the KSU door **90°**. Applying upward pressure, lift the door from its hinges.
3. Do not **turn** the power ON to the **KSU**.
4. Screw the top mounting screw half-way into the backboard.
5. Hang the KSU **vertically** on the top mounting screw (Figure 1).
6. Make sure the KSU is level.
7. Install the bottom and right-hand side screws. Tighten all screws.
8. Following the instructions on the label, install the Software Cartridge (Figure 2).

Figure 1 — Mounting the KSU

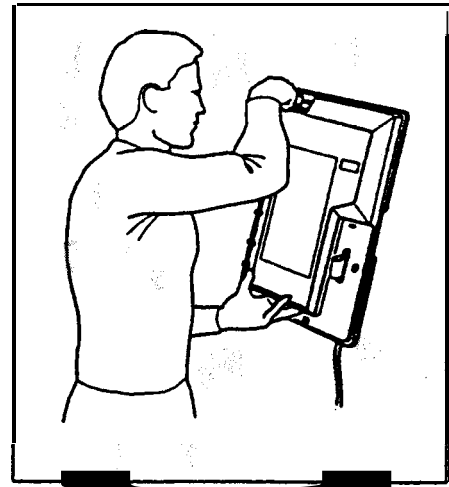
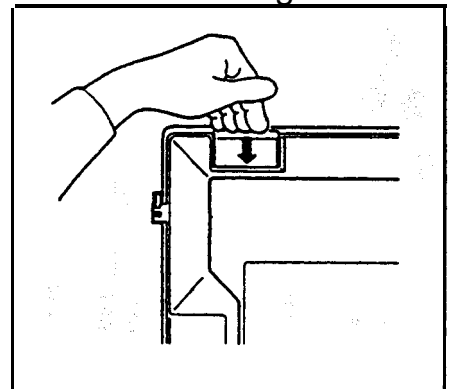

Figure 2 — Inserting the Software Cartridge



External lines and internal wiring

Connecting external lines

1. Cross-connect the external lines from the distribution panel directly to the modular jacks located on the left side of the KSU. Line 1 is connected to the bottom jack. (Each jack is identified with its **line number**.)
2. Route the line cords on the KSU (Figure 3).

Connecting internal wiring

1. Plug the **25-pair** cable into the KSU (Figure 4).
2. Route the cable to the distribution panel.
3. Connect the wires to the appropriate pins on the internal distribution block. (For details see Chart 2 — Internal Wiring.)
4. Cross-connect the internal wires to the corresponding pins on the internal distribution block.
5. Connect the **Norstar** telephones to your internal wiring loop. A pair of wires is required for each internal telephone. (See Chart 2 — Internal Wiring.)

Figure 3 — Routing the line cords

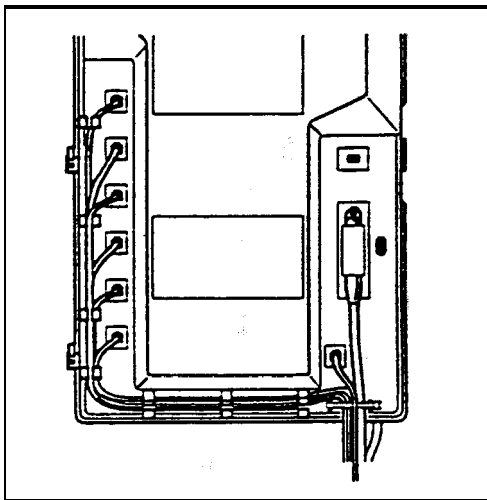
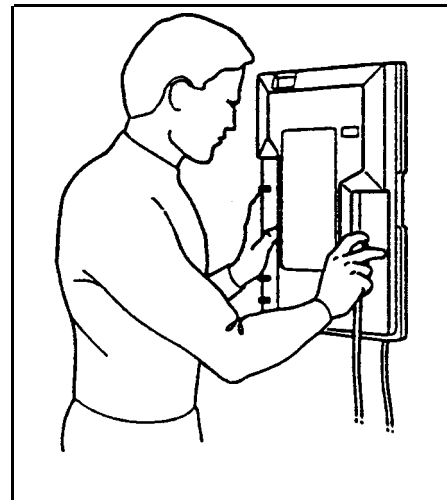

Figure 4 — Plugging in the **25-pair** cable



Internal wiring chart

Chart 2 — Internal Wiring:

50-Pin Distribution Block				
Pin	Wire Color	Service	Telephone, Port (Defaults)	
26 1	white-Blue Blue-White	T R	(21)	1
27 2	white-orange Orange-White	T R	(22)	2
26 3	White-Green Green-White	T R	(23)	3
29 4	White-Brown &own-White	T R	(24)	4
30 5	White-Slate Slate-White	T R	(25)	5
31 6	Red-Blue Blue-Red	T R	(26)	6
32 7	Red-Orange Orange-Red	T R	(27)	7
33 6	Red-Green Green-Red	T R	(28)	6
34 9	Red-Brown Brown-Red	T R	(29)	9
35 10	Red-Slate Slate-Red	T R	(30)	10
36 11	Black-Blue Blue-Black	T R	(31)	11
37 12	Black-Orange Orange-Black	T A	(32)	12
38 13	Black-Green Green-Black	T R	(33)	13
39 14	Black-Brown Brown-Black	T R	(34)	14
40 15	Slack-Slate Slate-Black	T R	(35)	15
41 16	Yellow-Blue Blue-Yellow	T A	(36)	16
42 17	Yellow-Orange Orange-Yellow	Spare Spare		
43 16	Yellow-Green Green-Yellow	Spare Spare		
44 19	Yellow-Brown Brown-Yellow	Spare Spare		
45 20	Yellow-Slate Slate-Yellow	Spare Spare		
46 21	Vi-Blue Blue-Violet	Spare Spare		
47 22	Violet-Orange Orange-Violet			External Paging (audio signal)
48 23	Violet-Green Green-Violet	N/O Common		External Paging (relay contact)
49 24	Violet-Brown Brown-Violet	N/O Common		Auxiliary Ringer (relay contact)
50 25	Violet-Slate Slate-Violet	Music Ground		External Music (audio signal)

Note: T and R are symbolic representations of the telephone connections and should not be confused with Tip & Ring. Telephone connections are non-polarized.

Installing the Emergency Telephone

An optional Emergency Telephone (ET) automatically connects to Line 1 when the power fails or when power to the KSU is disconnected.

Note: Use only a standard **500/2500** single-line telephone for this purpose.

Installation Procedure



1. Connect the customer supplied Emergency Telephone to the Emergency Telephone (ET) jack on the lower right hand corner of the KSU panel.
2. Label the telephone: "Emergency Telephone Only. This telephone functions only when AC power to the telephone system is turned OFF."

Testing the Emergency Telephone

The Emergency Telephone must be tested with the KSU power OFF.

1. Pick up the Emergency Telephone receiver.
If you hear a dial tone, both the Emergency Telephone and Line 1 are functioning properly.
OR
If you hear no dial tone, check tine 1. Unplug the Emergency Telephone and connect it directly to Line **1** on the distribution block
2. If you still do not hear a dial tone, check the line connections and operation of the Emergency Telephone.
3. If the previous steps have been verified and there is still no dial tone at the Emergency Telephone, replace the KSU.
4. Repeat the Emergency Telephone test.

Installing the Norstar telephones

1. Connect the receiver cord to the telephone modular jack (indicated by the symbol at right). Route the cord through the appropriate cord guide in the base of the telephone. 
2. Connect the line cord into the telephone line modular jack (indicated by the symbol at right). Route the cord through the appropriate cord guide. 
3. Connect the other end of the line cord into the modular jack wired from the distribution panel.
4. When the telephone is connected to the KSU, the telephone display and indicators flash briefly while the **telephone** initializes. The telephone is operational when the display shows the **default** time and date.

Norstar telephones cannot be used as off-premise extensions (OPX). For OPX applications, use the **Norstar** Analog Terminal Adapter (**ATA**) and a single line telephone. (See the **ATA** installation card for details.)

CAUTION

Never install or remove the Software Cartridge when the KSU power is ON.

Installing a wall-mounted telephone

1. Remove the beveled wall-mounting base from the back of the telephone. Grip the telephone, and with your thumbs, push on the wide edge of the base to pop it out from the telephone.
2. Remove the receiver clip from the wall-mounting base. Install the clip in the forward lip of the receiver rest.
3. Use a screwdriver or similar tool to remove the center knock-out panel in the wall-mounting base.
4. Screw the base to the wall (thin end up) so that the wall jack projects through the knock-out.
5. Connect one end of the line cord to the telephone line jack (indicated by the symbol below).
6. Route the line cord through the appropriate cord guide in the bottom of the telephone.
7. Connect the other end of the line cord to the wall jack. Store any spare cord neatly in the base of the telephone and mount the telephone on the base.

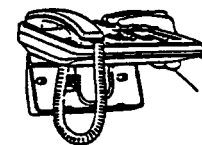
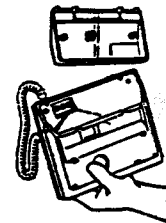
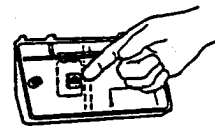
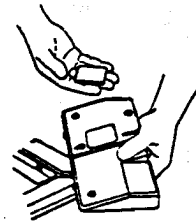
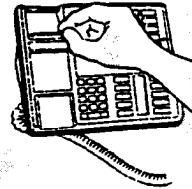
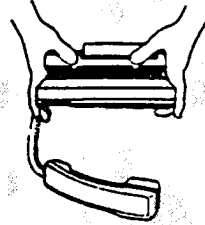

WARNING

If the telephone line is supported with auxiliary power, the power source must be a Class 2 power source that is UL and CSA Listed.

Installing optional equipment

Note: Optional equipment must meet with local regulatory approval standards.

Auxiliary **Ringer** (Customer Supplied)

The Norstar KSU provides a control contact to operate an external ringer. It does not provide ring current or DC voltage. The ringer relay contacts must **not draw** more than 50 mA from a 30 Vdc source.

1. Follow the manufacturer's installation instructions.
2. Connect the Auxiliary Ringer generator to the **50-pin** distribution block as shown in Chart 2 — Internal Wiring.

External Music source (Customer Supplied)

This equipment provides music for the Music on Hold and Background Music features. These features must be enabled through Configuration (see the Programming section in this Guide). Refer to the Compact **DR5** System **Coordinator** Guide and Compact **DR5** Programming Record for more information.

The music source can be any approved low-power output device (such as a radio) with a high-impedance earphone jack. The recommended KSU input level is 1 Vrms across an input impedance of 3300 Ω .

CAUTION

To avoid damage to audio equipment, ensure that the polarity of the audio input is correct according to the KSU internal wiring chart.

1. Connect the music source and ground to the 50-pin distribution block as shown in Chart 2 — Internal Wiring.
2. Activate the Music on Hold or Background Music feature and adjust the volume at the music source to a comfortable level.

Note: Background Music volume for each telephone can also be controlled at the telephone:

External Paging (Customer Supplied)

The paging system uses the speakers on **Norstar** telephones and can also be used with external loudspeakers provided by the customer. The paging output from the **Norstar** KSU is 775 mVrms across an input impedance of 600 Ω .

1. Follow the manufacturer's installation instructions.
2. Connect the paging system audio input to the **50-pin** distribution block as shown in Chart 2 — Internal Wiring.
3. Connect the paging relay (max. rating: 30 Vdc @ 50 mA) to the **50-pin** distribution block as shown in Chart 2 — Internal Wiring.

Note: **Norstar** external paging does not support talk-back paging equipment unless an external line port is used.

Powering up the KSU

1. Power ON the KSU by plugging in the power cord. The red power LED on the KSU should turn ON.
2. If the red LED does not **turn ON**, verify that there is power at the ac outlet.
OR
if there is power at the ac outlet, replace the KSU.

Note: Re-install the KSU door once the system is operational.

Programming

Programming a newly installed **Norstar** system involves the completion of the following programming steps:

- System Startup
- Configuration
- General Administration

Programming overview

System Startup

System Startup is performed only when the system is first installed. System Startup allows you to **select** one of three programming templates: Square, Hybrid, or PBX. Each template initializes all of the programming data to system wide defaults.

Configuration

Allows programming of basic line and telephone characteristics.

Configuration code: This code gives access to:

- A. Configuration**
- B. General admin
- c. set COPY
- D. System Version**

General Administration

Allows the customization of the system at installation and on an ongoing basis. (See the *Compact DR5 System Coordinator Guide* for details on Administration programming.)

Note: B. General admin is accessible through the Configuration code. For System Coordinators, Administration programming can only be accessed by using an Administration code. An optional password may be used after entering the Administration code.

Set Copy

This feature is **used** to copy **all** of **the** system programming (Configuration and Administration) from on8 **telephone** to another. **Personal** programming on individual **telephones** can also **be** copied, but system-level programming will **be** copied along with it. Copy appears on **the** display as **C. Set** COPY and is **accessible** by using **the** Configuration code.

S y s t e m V e r s i o n

System Version **allows** you to not8 **the** version numbers of the software in the System Processor (SP) software, residing in the Feature Cartridge.

Version numbers can be used to determine whether you have the latest software release, and to trace a software fault if on8 occurs. For instance:

- SP version numbers can indicate a Software Cartridge incompatibility.
- SP and telephone version numbers can indicate a **telephone** version incompatibility.
- SP and functional terminal version numbers can indicate a functional terminal incompatibility.

To check the version number, start with the display showing **D. System Version**:

1. Press .
The display shows the version number of the SP.
2. Writ8 the SP version number on the appropriate Maintenance record.

Chart 3 — Programming Overview

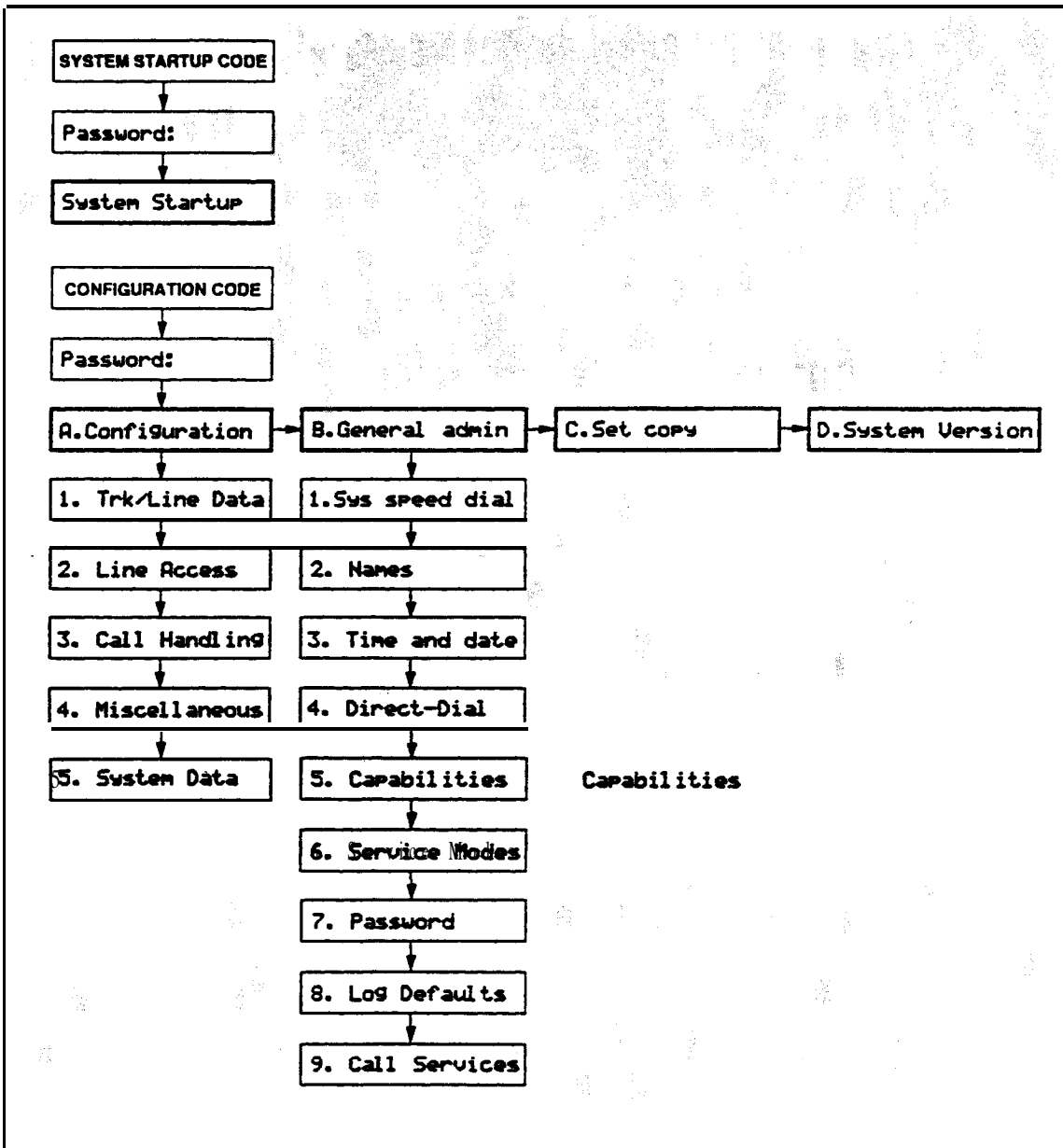

The Norstar M7100, M7208, M7310 and M7324 Telephones can be used with the Compact DR5 system. Programming is done with an M7208, M7310, or M7324 Telephone. as shown on the following page.

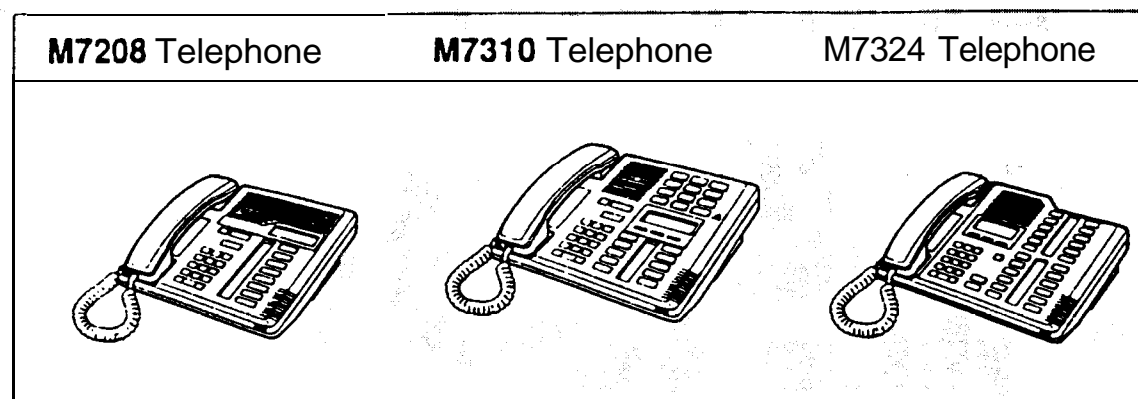

You should have two aids to assist you in completing your programming:

Programming Record

The *Compact DR5 Programming Record* may already have been completed before installation. It describes the settings to be programmed into a **Norstar** system. Also, the *Programming Record* serves as a record of the settings programmed at initial installation and during subsequent upgrades.

Default settings: Many of the programming settings are determined during System Startup according to the selected template. Any of these settings may later be changed during programming. In the *Programming Record*, these default settings are shown in bold characters for the Square template.

Programming Overlay

The Programming Overlay is placed over the buttons of the **Norstar** telephones, and provides an aid in recognizing the function of the buttons during programming. The Programming Overlay can be found at the end of this guide.

The Programming Overlay for the M7208 Telephone is placed over all of the eight memory buttons (Figure 11). The Programming Overlay for the M7310 and M7324 Telephones (Figure 11) is placed over the top four memory buttons with indicators.

Figure 11 — Programming Overlay for the M7208 Telephone (top) and for the M7310 and M7324 Telephone (bottom)

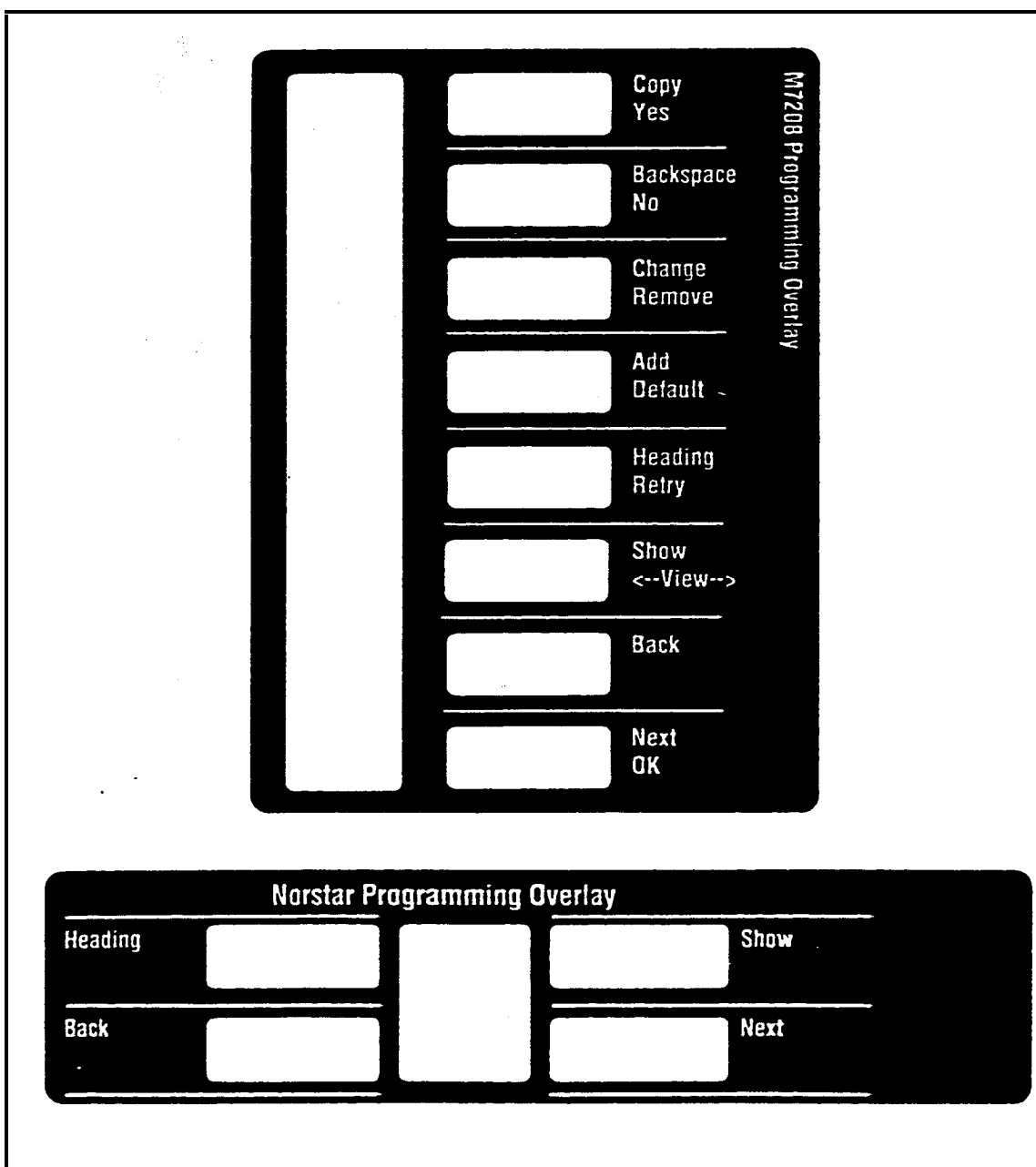

System Startup overview

Perform System Startup after the system hardware has been installed and powered up. System Startup is used by the installer to choose the appropriate template before starting programming. There are three templates available: Square, Hybrid and PBX. The Compact *DR5 Programming Record* explains what each template does.

CAUTION

Startup is to be used for initial installation only, or after a system software upgrade with a new Software Cartridge. Do not use Startup after **Norstar** is in operation; the procedure erases all system administrative data.

All Configuration and Administration data will be retained for at least three days if the power fails or if the **Norstar** system is powered OFF. After three days without power, it may be necessary to perform System Startup again.

Note: Do not attempt Directory Number (DN) changes within two minutes of System Startup (using the Change **DNs** option of **5. System Data**). Attempting a DN change may disable the ports.

System Startup Access

The System Startup Access code and a password are used only by Installers to access System Startup.

The correct Startup code must be entered no later than 15 minutes after the **Norstar** system has been powered up. A Startup code entered at any time after the 15 minute interval results in the message *Startup denied*. If this occurs, re-power the system again to prepare for the System Startup process.

Entering System Startup

Note: If at any time you do not wish to continue with entering System Startup, press **RTS**.

1. Select a **Norstar** telephone from which to program. Place the correct Programming Overlay over the buttons of the telephone. A button may be used during programming when its indicator ► turns **ON**.

2. Using the telephone dial pad, press the System Startup Access code:

Feature * * 7 8 2 7 8 8 7

Which is the same as:

Feature * * S T A R T U P

3. At the Password: prompt, enter the Installer password:

2 6 6 3 4 4

Which is the same as:

C O N F I G

(The Installer password is not shown on the display.)

The default password is **CONFIG**, which you will have to use if this is the first time that Configuration programming has been accessed. If Startup must be performed on an existing system which has already been programmed, the Installer password might have been changed. The change should have been properly recorded in the *Compact DR5 Programming Record*.

4. If the password is entered correctly, the display shows Reset **memory?** Proceed to change the system template as described in the next procedure.

OR

If the Password has been entered **incorrectly**, Password: remains on the display. Press the **RETRY** display button (or

Retry

on the M7208 Telephone) and re-enter the correct password.

Choosing the system template

1. The display shows Reset memory? To continue with System Startup and choose the system template, press **YES** (or on the M7208 Telephone).
OR
To exit from System Startup, press (or **CANCEL** on the M7310 and M7324 Telephone).
2. The display shows **Templ** ate: Square. To accept the Square template, go to step 3.
OR
To select another template, press **CHANGE** (or on the M7208 Telephone) to select another template.
3. To accept the template shown and exit from System Startup, press **NEXT** or (or on the M7208 Telephone). System Startup is complete when the time and date appear on the telephone display.

Chart 4 — System Startup

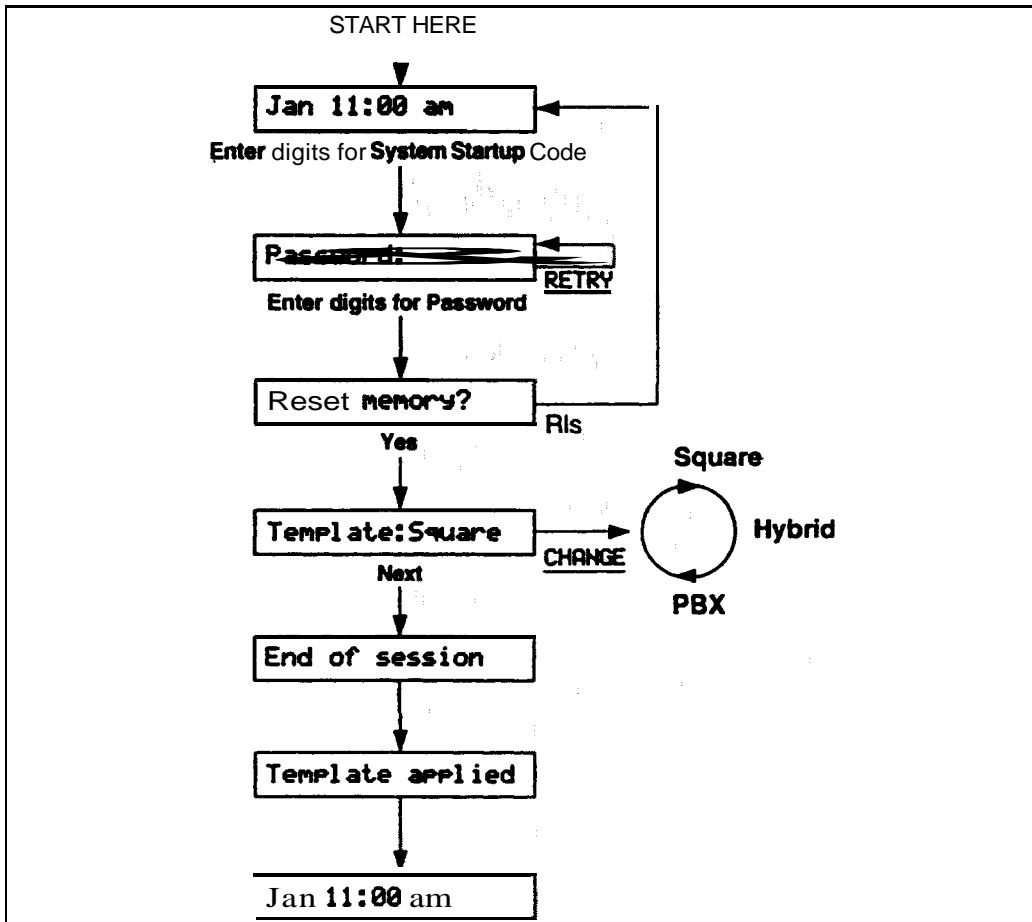

Configuration Overview

Configuration programming allows you to specify basic system characteristics for the customer site. Configuration is not accessible to System Coordinators.

Configuration provides access to the following programming sections:

1. Trunk/Line Data
2. Line Access
3. Call Handling
4. Miscellaneous
5. System Data

Configuration Access Code

1. Press * * 2 6 6 3 4 4
OR
Press * * C O N F I G

Installer Password

1. At the Password: prompt, enter in the existing Installer password. The default password is **CONFIG**, which you will have to use if this is the first time that Configuration programming has been accessed.
2. If the password is entered correctly, the display shows **A. Configuration.**
OR
If the Password has been entered incorrectly, Password: remains on the display. Press the **RETRY** display button (or on the M7208 Telephone) and re-enter the correct password.

Note: For the security of Configuration data, do not give the Startup access code to anyone.

Chart 5 — Configuration Overview

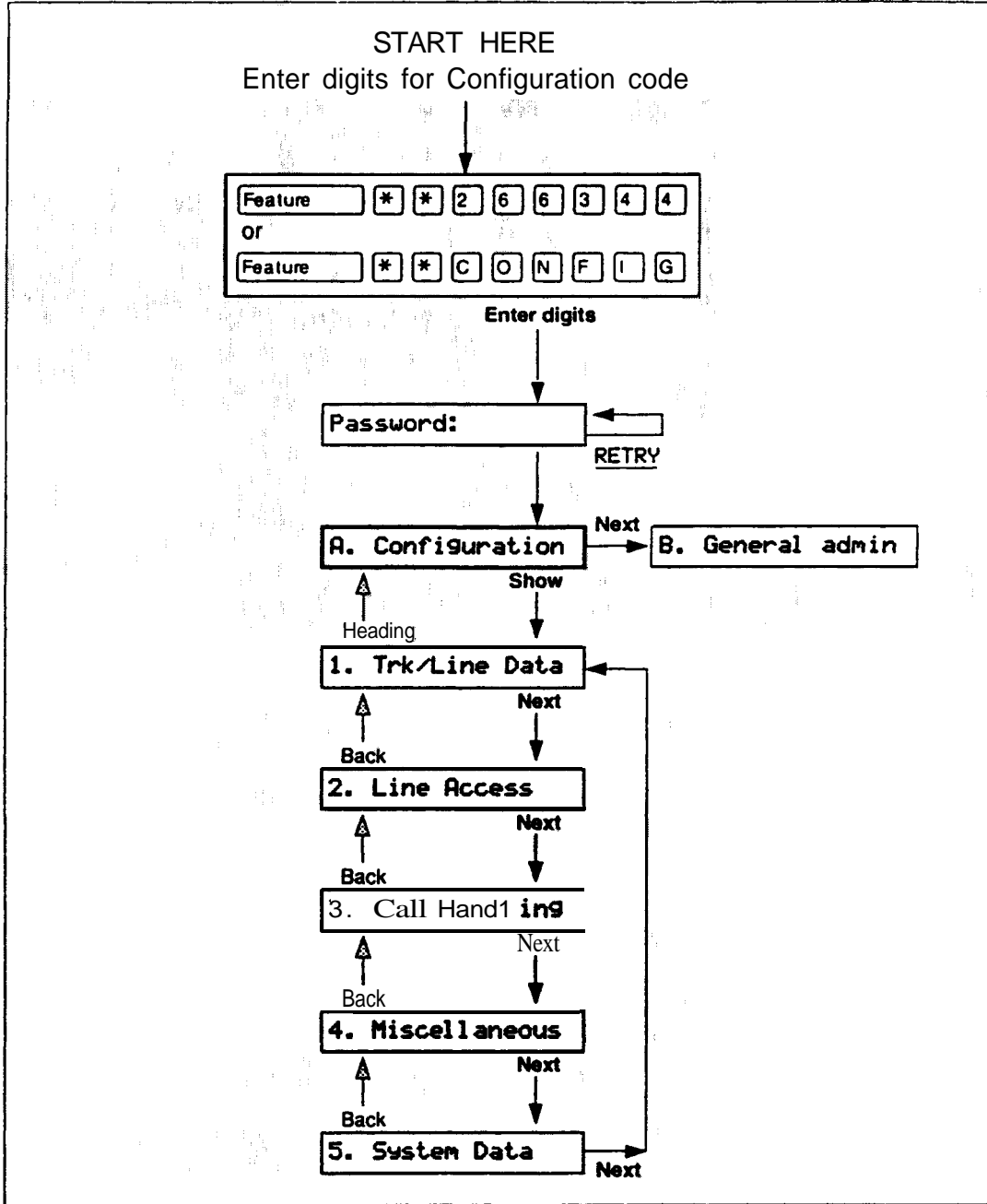

Trk/Line Data

Use 1. **Trk/Line** Data to program characteristics for each external line.

When you are finished programming the **Trk/Line** Data settings for a line, you may copy those exact settings to another line by using the **COPY** display button (or on the M7208 Telephone) at the Show 1 **line:** prompt.

Entering the line to be programmed

Enter any available line number between 01 and 06.

Dial Mode

A dial mode can be assigned to each line. The mode defines the signaling that the line will use. The default mode is Pulse.

Another possible mode is Tone.

- Lines that use Dual Tone Multi Frequency (DTMF) tones, should be set to Tone.

Full **Autohold**

An external line is affected by Full Automatic Hold when it is placed on hold when no digits have been dialed on it, but another line is selected. The default setting is No, which means that the external line is not held. Another possible setting is Yes.

- This feature is useful if a “hotline” or “ring down tie line” is required.

Line Type

A type can be assigned to each line. The type defines how the line is to be used in relation to other lines in the system. The default type is Public. Other possible types are Private, Pool A, Pool B and Pool C.

- If you define a line as Public, the line can be accessed by more than one telephone.
- If you define a line as Private, the line can only be assigned to one telephone.
- If you assign a line to a Line Pool, that line can be available to any telephone that is assigned access to that Line Pool.
- If a line is assigned to one of the three Line Pools, but the line is not assigned to any telephone, that line can only be used for making outgoing calls.
- If a line is assigned to one of the three Line Pools, you must remember that there are still two more programming settings that must be assigned before a Line Pool can be used:
 - You must assign Line Pool Access to telephones in Line Access.
 - You must assign Line Pool Access codes in Miscellaneous programming.

Prime telephone

The Prime telephone provides backup answering for the selected line. The default Prime telephone has the internal number 21. Other possible settings are any allowable internal numbers, or None.

- Each line can only have one Prime telephone.
- Any Prime telephone can be assigned to provide backup answering for more than one external line. All of these lines do not necessarily have to appear on a line button with an indicator; however, monitoring lines is made easier if there is a line button for every external line.

Auxiliary ringer

An auxiliary ringer can be enabled or disabled for calls coming in on the line. The default setting is Yes, which means that the ringer will ring. Another possible setting is No.

Auto privacy

Auto privacy can be enabled so that other users who have access to a line on their telephone, cannot use that line while a call is already in progress on the line.' If disabled, Auto privacy allows a user to select a line in use at another telephone, and join an **established** call.

Chart 6 — Trk/Line Data

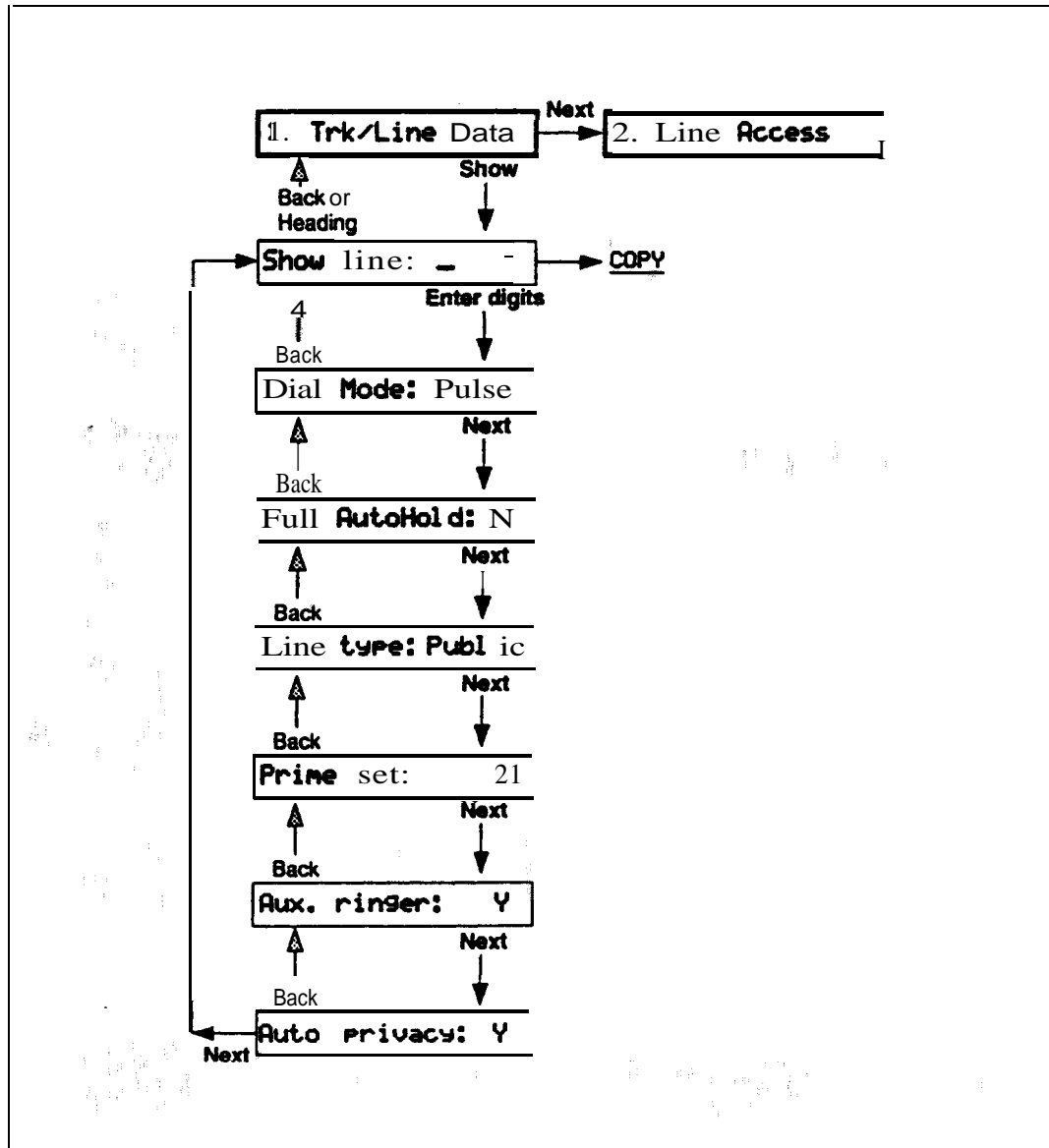

Line Access

Use Line Access to program characteristics for each telephone. These characteristics establish which lines the telephone may use.

When you are finished programming the Line Access settings for a telephone, you may copy those settings to another telephone by using the COPY display button (or on the M7208 Telephone) at the Show set: prompt.

Entering the telephone to be programmed

Enter any available DN. Default DNs range from 21 to 36. DNs can be later changed to a new number in **5. System Data** of Configuration programming.

Note: Settings are automatically applied for the Analog Terminal Adapter (**ATA**) if installed. See the **ATA Installation Guide** for the defaults.

Line assignment

You can assign one or more lines to the telephone. You can remove lines assigned to the telephone. The default line assignments for the Square template are Line 1 and Line 2 to each telephone. Any other lines can be assigned to each telephone.

- A Private line can only be assigned to one telephone. (It is also automatically assigned to the Prime Telephone for that line.)
- If you assigned the PBX template in System Startup, a Line Pool is assigned to the telephone instead of external lines. You can add lines if you wish. This would allow the telephone to ring for incoming external calls.
- If a line is assigned to a Line Pool, but is not assigned to any telephone, that line can only be used to make outgoing calls.

Answer DNs

Up to four buttons on a telephone can be programmed for answering calls to the **DNs** of other telephones. The default is No Answer **DNs**.

Ringina

For 'each line assigned' to a telephone; you can determine whether incoming, calls will ring at the telephone. Possible settings are Ring and No Ring. The default setting is Ring.

Line pool access

You can determine which Line Pool each telephone has access to. Possible settings are Yes and No. The default setting is No for each of the three line pools, which means no telephone has default access to Line pools.

- Assigning a Line Pool to a telephone saves on the number of buttons required for external lines on the telephone.

Intercom buttons

You can determine the number of Intercom buttons on the telephone. Possible settings are **0, 1,** or 2. The default setting is 2.

- A minimum of two Intercom buttons are required for conferencing with two other **Norstar** telephones in the same system.
- A minimum of one Intercom button is required if internal calls are to be made or received from the telephone or Line Pools are to be accessed from the telephone.

Prime line

You can assign the Prime line for each telephone. The Prime line is the first line to be automatically provided at a telephone when you make a call. The appropriate Prime line will depend on the customer's requirements. The default setting is None, which means that no Prime line is assigned to the telephone. Other possible settings are an external line (Line number), Line Pool A, Line Pool B, Line Pool C or intercom (I/C).

- A Prime line is not related to the operation of a Prime telephone.

Chart 7 — Line Access

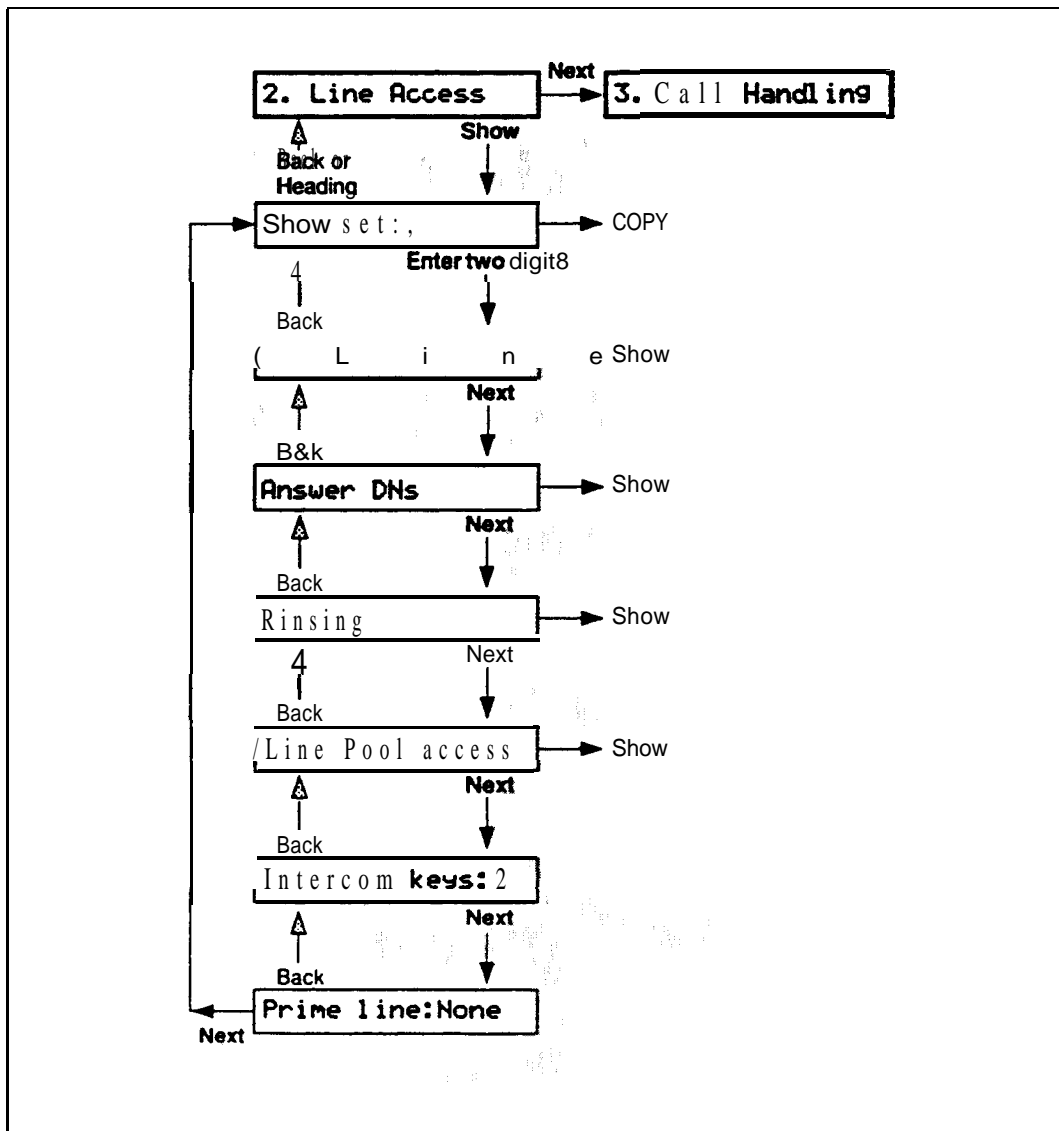

Call Handling

Use Call Handling parameters to program system-wide characteristics for certain call features. These characteristics are not associated in programming with any particular line or telephone.

Held reminder

Choose if the Held Line Reminder feature is to be active for **all** external lines. Possible settings are Yes and No. The default setting is No. If Yes, the programming menu takes you to the Remind delay setting.

Remind delay

Assign the delay (in seconds) before the Held Line Reminder feature begins at the telephone which has put an external line on hold. Possible delays are 30, 60, 90, 120, **150** and 180 seconds. The default delay is 60 seconds.

- This setting does not appear if Held Line Reminder is not active.

DRT to prime

Choose if the Delayed Ring Transfer to Prime telephone feature is to be active for all external lines associated with the Prime telephone. **If** yes, the programming menu takes you to the DRT delay setting. Possible settings are Yes and No. The default setting is Yes.

- Ensure that you have an operational Prime telephone.
- This setting applies only to external lines with an assigned Prime telephone.

DRT delay

Assign the delay (number of rings) before an unanswered external call is redirected to the Prime telephone. Possible delays are 1, 2, 3, 4, 6 or 10 rings. The default delay is 3 rings.

- To estimate the delay time in seconds, multiply the number of rings by six.

Transfer callback

Choose the delay (number of rings) before a transferred external call will callback to the originating telephone. The possible delay is 3, 4, 5, 6, or 12 rings. The default delay is 3 rings.

- To estimate the delay time in seconds, multiply the number of rings by six.

Park prefix

Park prefix assigns a one digit code number to retrieve a parked call. The default Park prefix is 1. Any digit from 0 to 9, or none, can be assigned, providing it is not the first digit of a DN or Line Pool access code.

Park timeout

Assign the number of seconds before a parked external call will callback to the originating telephone. The possible timeout is 30, 45, 60, 90, 120, 150, 180, 300, or 600 seconds. The default timeout is 45 seconds.

Camp timeout

Assign the length of delay before a camped call is returned to the telephone which camped the call. The possible timeout is 30, 45, 60, 90, 120, 150, or 180 seconds. The default timeout is 45 seconds.

Directed pickup

Directed pickup allows any telephone within the system to answer calls by specifying the ringing telephone's number (unlike Call Pickup Group which only allows pickup of calls within a specified group of telephones). The default is Yes.

On hold

Choose what a caller will hear on an external line when the line has been put on hold. Possible settings are Tones, Music, or Silence. The default setting is Tones.

- A customer supplied music source must be connected in order to hear music.

Chart 8 — Call Handling

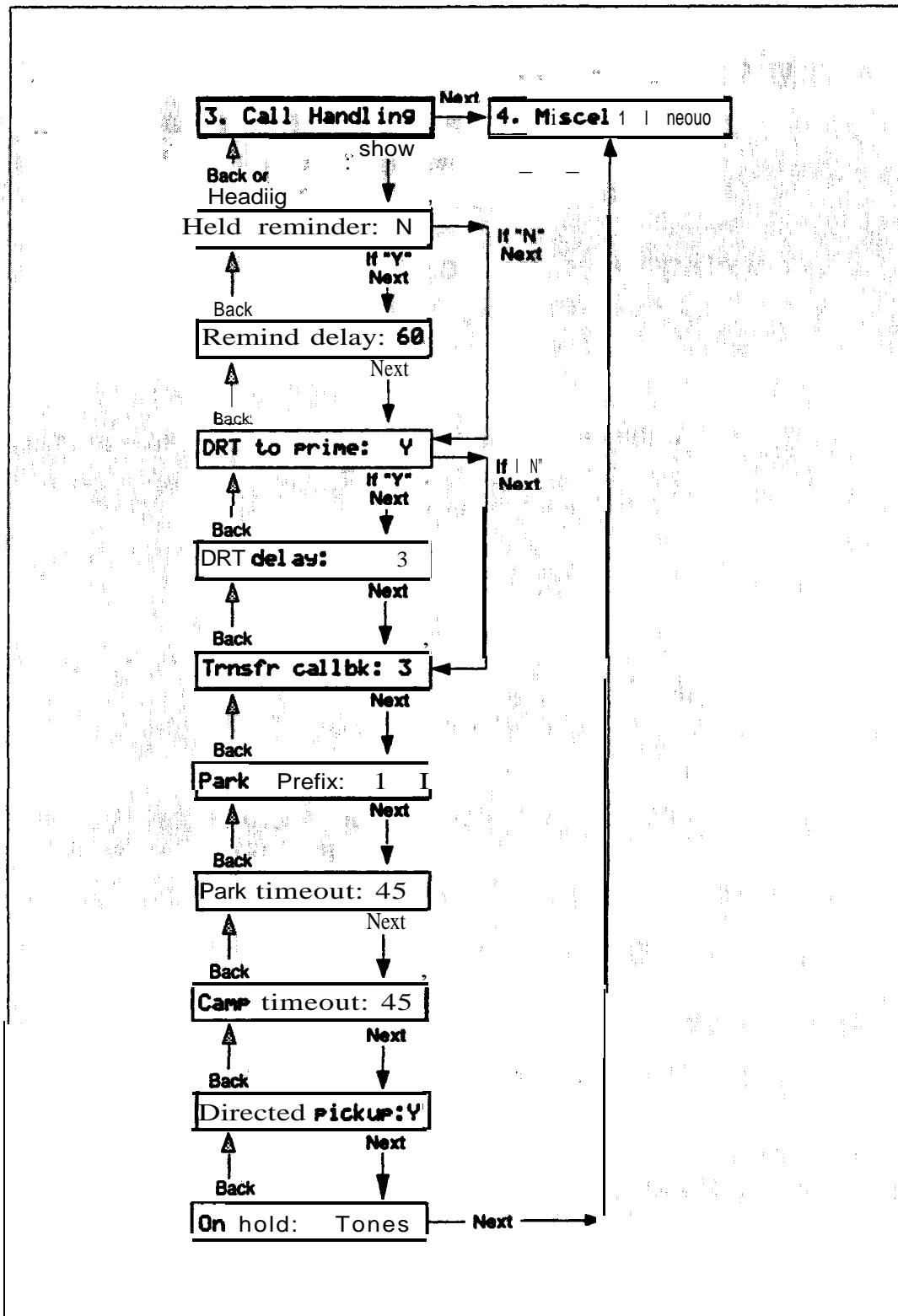

Miscellaneous

Use Miscellaneous settings to program various system-wide characteristics. These characteristics are not associated in programming with any particular line or telephone.

Background Music

Choose if the Background music feature is to be available within the **Norstar** system. Possible settings are Yes and No. The default setting is No.

- If this feature is enabled, ensure that an external music source has been connected to the KSU. (This music source is also used for the Music on Hold feature.)

Direct-dial digit

Choose the digit you dial in order to get the Direct-dial Telephone to ring. The possible settings are any valid digit from 0 to 9, or None. The default setting is the digit zero.

Link time

Assign the Link time (in milliseconds). Possible times are 100, 200, 300, 400, 500, 600, 700, 800, 900, 1000 milliseconds. The default Link time is 600 milliseconds.

- The Link time required will depend on the requirements of the host PBX, **Centrex**, or other switching system that must be accessed by **Norstar**.
- Link is another name for Recall or Flash.

Telephone relocation

Choose if the Set Relocation feature is to be active. Possible settings are Yes and No. The default setting is No.

- It is advisable to turn Set Relocation ON after the telephone installation and programming has been done. This provides you with more flexibility in testing equipment. If this feature is disabled, and a telephone is moved, that telephone's internal number and Administration data remain with the physical port.

- If new telephones are being installed at the same time that other telephones are being relocated; you should perform the following procedure to ensure that Set Relocation occurs:
 1. Select Yes to **turn ON** Set Relocation. *
 2. Unplug the telephone that is to be relocated.
 3. Plug the telephone into its new location.
 4. Plug a new telephone into the old **location** of the telephone that was moved.

Host delay

Host delay programs the delay in milliseconds between the selection of an outgoing line and the moment that **Norstar** sends dialed digits or codes on that line. The default is 1000 milliseconds.

External code

Assign a one-digit External line access code, or none. The default is 9. The External code allows an M7100 Telephone or an **ATA** to access external lines.

Line pool codes

Assign Line Pool Access codes for each of the three possible Line Pools. The possible settings are a one to four digit number (starting with **6, 7, 8, or 9**) or None. The default setting is None.

- The codes cannot start with the same first digit of an internal number already assigned to a telephone.
- Codes starting with the same number must be the same length.
- Ensure that the System Coordinator knows the codes.

Installer password

This allows you to change the Installer password for access to Configuration programming. The possible setting is any combination of one to six letters or numbers. The default Installer Password is **2 6 6 3 4 4** which is the same as **CONFIG**.

- The default password is required to first gain access to Configuration programming. However, it is advisable to change that password to a new one.

Chart 9 — Miscellaneous

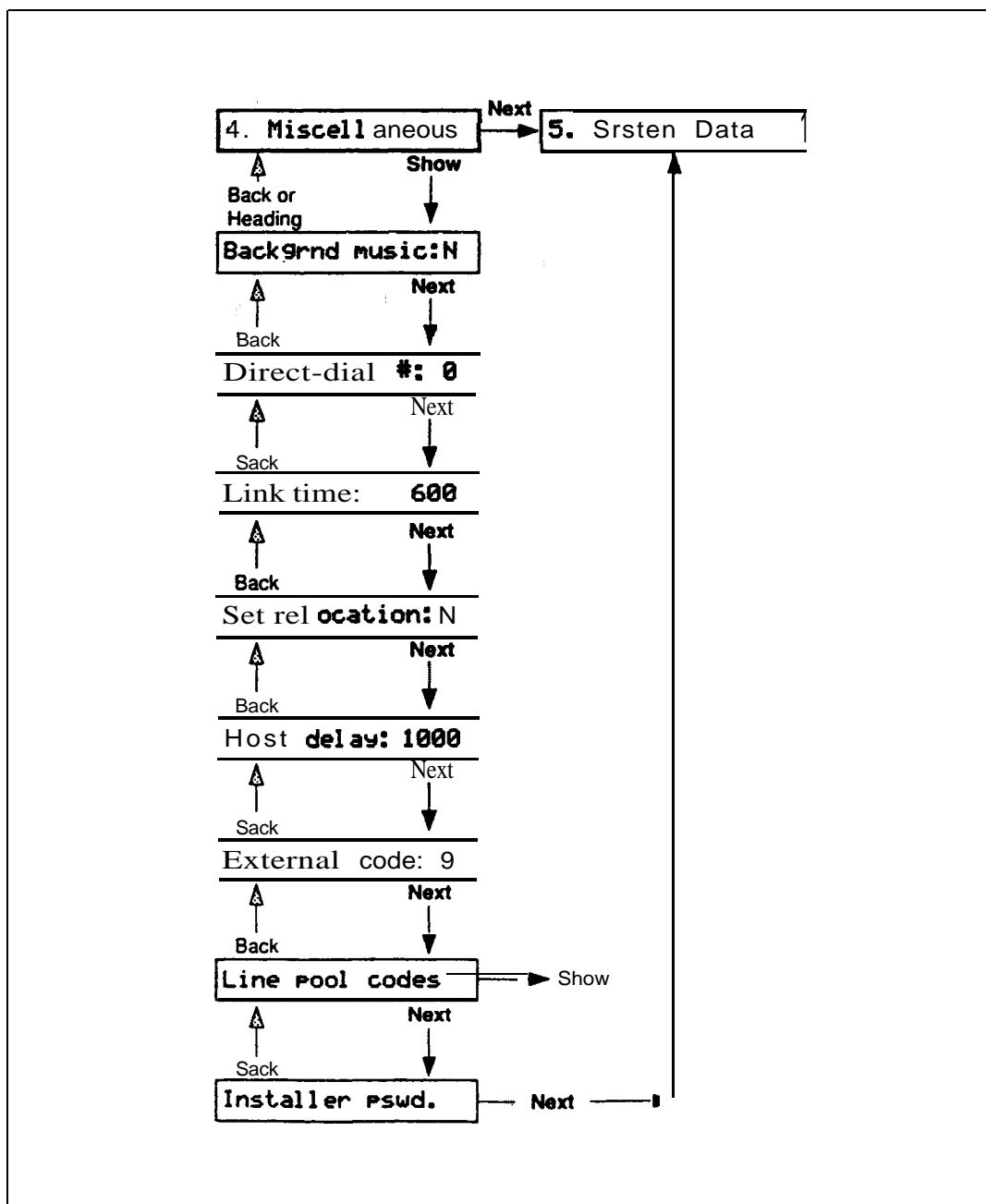

System Data

Use this to change the internal number or Directory Number (DN) of an individual telephone.

Note: Do not attempt internal number changes within two minutes of System **Startup**.

Individual DNs

Enter the appropriate internal number when you are prompted for the old and the new internal number. A message will appear on the display if either internal number is invalid. The possible settings are any valid internal number **between** 20 and 99. There is no default setting.

- No internal number changes occur until the Configuration session ends. (Press the **[Ris]** button.)
- If the “new internal number” already existed for another telephone, that telephone will be given the “old internal number”.
- There can be only one telephone for each internal number.
- An internal number and a Line Pool Access Code cannot start with the same digit.

Chart 10 - System Data

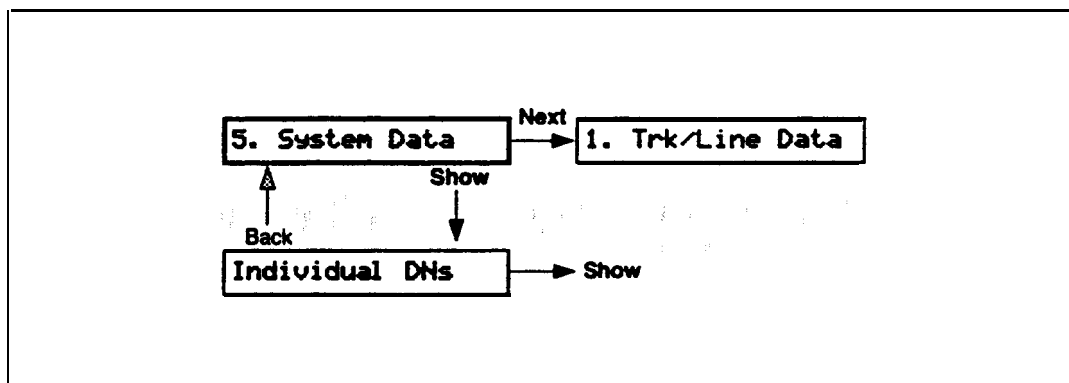

Note: If you change a DN, you cannot continue programming in any of the other sections while in the same Configuration session. Press the **[Ris]** button to end the session.

Set Copy

Use this for copying System data (programming) or System and User Administration data (Personal programming) from one telephone to another. System data is programmed in Configuration and Administration. User Administration programming is performed by the user at the individual telephone, and allows the telephone to be customized according to the user's requirements.

Set Copy Options

COPY: SYSTEM data

When this message appears on the display, you can choose to copy System data.

COPY: SYSTEM+USER

When this message appears on the display, you can choose to copy System and User data. Both telephones must be the same model and connected to the system before this option can be used.

Note: Do not confuse C. Set COPY with the **COPY** display button (or **Copy** on the M7208 Telephone), which is for selective copying of specific groups of settings from one telephone or external line to another.

Set Copy characteristics which can NOT be copied

- Autobump
- Autolog options
- Log password
- Directory Number (DN)
- Telephone name
- Private line appearances
- Prime telephone designation for a line
- Direct-dial telephone designation
- Extra-dial telephone designation
- Control telephone designation for a line
- Service mode Ringing telephone designation for a line
- Receive tones
- Logging set designation
- Show external Voice Message
- Log space
- First display

Characteristics which CAN be copied

Except for those characteristics previously listed, all telephone related settings can be copied to a destination telephone, overriding any previous programming. Listed below are the System level settings and User Administration settings which can be copied.

System settings in Configuration programming

2. Line **Access**

- Line assignment
- Answer DNs
- Ringing line preference
- Line pool access
- Number of Intercom buttons
- Prime line designation

System settings in Administration programming

5. **Capabilities**

- Set Filter
- **Set Lock**
- Full handsfree
- Handsfree answerback
- pickup group
- Paging
- Auxiliary ringer
- Direct-Dial
- Forward on busy
- Forward on no answer
- Receive tones
- Priority call

9. **Call Services**

- **Autolog/Show Vmsg**

Personalized settings

if desired, the following Personalized settings can be copied along with the System data:

- Programmable button assignments (Internal Autodial, External Autodial, and feature access)
- Language choice
- Personal Speed Dial entries

Using Set Copy

You can only enter Set Copy through the Configuration access code and with the Installer password.

Entering Set Copy

After **A. Configuration** appears on the display:

1. Press **Next** twice.
The display shows **C. Set COPY**.
2. Press **Show** to go to **COPY: SYSTEM** data.

Chart 11 — Set Copy

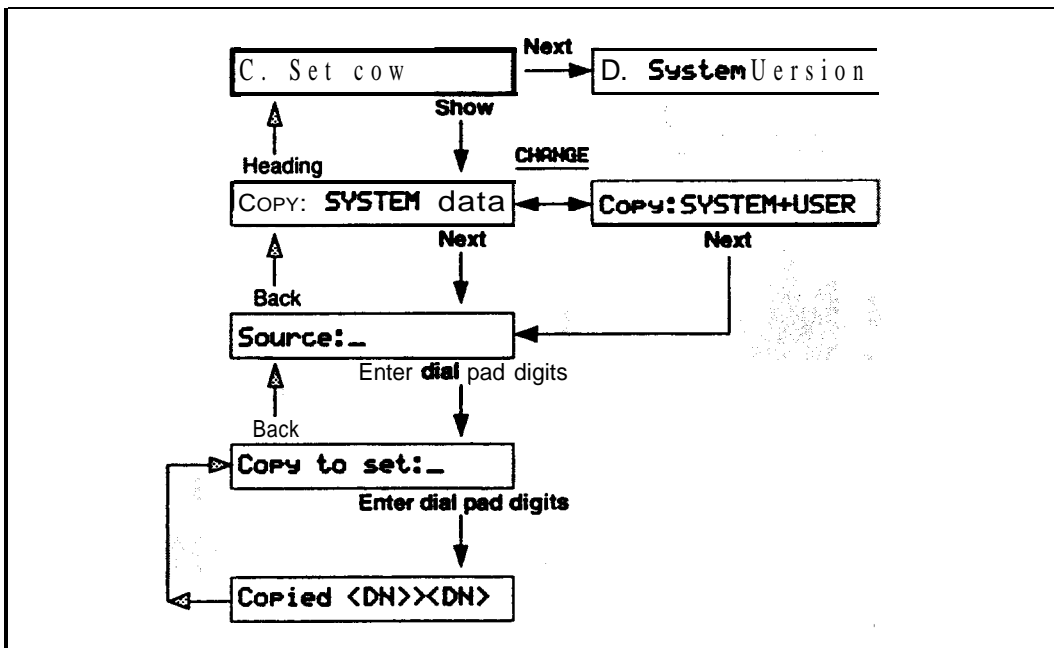

Troubleshooting

Testing the **lines** and **phones**

1. **Check all** external lines by selecting each line in turn at one of the **telephones** and verifying the **dial** tone. If you do **not** get a **dial** tone; plug a single-line **telephone directly** into the **external** line at the distribution panel. If you still do not get a dial tone, check all your wiring or contact your telephone company.
2. Check all internal connections by calling each **Norstar** telephone from another **Norstar** telephone.
3. **Check** the quality and clarity of all connections. Check for crackling, static, hums, or any other unusual noise,
4. If there are any problems, refer to other procedures in this section.
5. Verify the visual indicators:

To check a button:

1. Select a line or Intercom button. The ► indicator beside that button should appear.

To check the display:

1. Press **Feature** ***** **0**.
The display shows Press a button.
2. Press the **Rls** button to exit from this feature.

Analog Terminal Adapter (ATA) trouble

1. Check the single line telephone connection by using an installer's test telephone.
2. Check the connections to the jack.
3. Check the connections to the **ATA**.
4. Disconnect the **ATA** and replace it with a working Not-star telephone. If the telephone still works properly, this verifies that the KSU is working properly.
5. Verify that programming has been done as described in the *Norstar Analog Terminal Adapter Installation Card*.
6. If the trouble seems to be in the KSU, double check all wiring and programming options. If this does not help, refer to the KSU down section of Troubleshooting.

WARNING

This unit must be powered from a Class **2 power** source that is UL and CSA Listed.

Auxiliary Ringer trouble

1. If the Auxiliary Ringer is used for Service Modes, ensure that Service Modes is activated from the Control Telephone.
2. Check the wiring between the Auxiliary Ringer generator and the ringing device. (See the Internal Wiring chart.)
3. Check the wiring between the Auxiliary Ringer and the distribution panel.
4. Check the Auxiliary Ringer contact operation with an ohmmeter across the pins.
5. Check that the Auxiliary Ringer is programmed to ring for any of the following programmable settings:

Feature	Programmed in:
Ring for a specific line	A. Configuration (1. Trk/Line Data)
Ring for a specific telephone	B. General admin (5. Capabilities)
Service Modes Auxiliary Ringer	B. General admin (6, Service Modes)

Call Identification Interface

1. Use the Call Information feature on an incoming call to verify the operation of the **CII**.
2. Check the connections to the CII. Refer to the *CII Installer Card* for installation details.
3. Verify that the programming has been done as described in the *Compact DR5 Programming Record* and the *Compact DR5 System Coordinator Guide*.
4. Verify that you are subscribing to visual Call Display services from your local telephone company.
5. Replace the CII.

Dial tone absent (on external lines)

1. Use Button Inquiry (**Feature** ***** **0**) to check the feature of a programmable memory button that you think is assigned as an external line.
2. Check for a dial tone by using an installer's test telephone at the connections for the external line on the distribution block.
3. Check the connections between the KSU and the distribution block.

External Paging trouble

1. Check the wiring between the **50-pin** connector and the paging amplifier.
2. Check the wiring between the connections shown in the Internal Wiring chart.
3. Test the external Page feature (**Feature** **6** **2**) to ensure that it is working. The output from the **Norstar** KSU is **775 mVrms** across **600 Ω**.

KSU down

1. Check that the AC power cord is properly connected.
2. **Check** that the Software Cartridge **is firmly** seated in its slot.

CAUTION

Do not install or remove the Software Cartridge when KSU power is ON.

3. If AC power **is present** and the LED indicator on the KSU is OFF, replace the KSU.

Music on Hold/Background Music trouble

1. Ensure that the volume control (**Feature** *) is turned up and you are using the Background Music feature code ()
2. Check the applicable Configuration programming settings to ensure that the feature is enabled:

Feature	Programmed in:
Music on Hold	3. Call handling
Background Music	4. Miscellaneous

3. Check the wiring between the music source and the 50-pin connector.
4. Check the polarity of the connections between the music source and the distribution block.
5. Ensure that the music source is turned ON, is operational, and has the volume control properly adjusted.

Telephone dead

1. Check for dial tone.
2. Check the receiver cord connection.
3. Check the display. If the display is unreadable, ensure that the display contrast adjustment (**Feature**) is appropriate.
4. Check the internal wiring at both the modular jack and the distribution block.
5. Check the internal line.
6. If the problem persists, replace the telephone with a known working Norstar telephone.

Note: An internal line should have between 15 and 20 Vdc across the Tip and Ring when the telephone is disconnected.

Finishing up

If you are required to continue programming, refer to the *Compact DR5 System Coordinator Guide*.

Give the System Coordinator the *Compact DR5 Programming Record*.

Applying the button labels

If you perform all of the programming for a system, apply the appropriate button labels on the telephones. Before you apply button labels, activate the Button Inquiry feature (**Feature** * 0) to avoid activating features as you put the button labels onto the buttons.,

For the customer

Remember to leave the following items at the installation site:

For the System Coordinator

- *Compact DR5 System Coordinator Guide* (with the Programming Overlays)
- *Compact DR5 Programming Record*
- Optional equipment User Cards (for example, the BLF and **ATA**)
- Spare button labels and button caps
- Telephone User Cards (for the **M7100**, M7208, M7310, and M7324 as required)
- *compact DR5 Telephone Feature card*
- *Compact DR5 Prime Telephone card*

In the KSU pocket

- *Compact DR5 Installation Guide*
- *Optional equipment Installation cards* (for example, the BLF and **ATA**)

Personal programming,

Information on telephone feature programming and operation can be found in the *Compact DR5 System Coordinator Guide*.

Call Display services

Your **Norstar** system can access information contained in Call Display services offered by your public telephone company, and uses that information to provide additional messaging tools to the **Norstar** user.

Note: You can access Call Display information only if you subscribe to the services, and if you have Call Identification Interface hardware installed. Contact your Service Representative for more information.

Call Display information may be shown on your telephone display when a call is alerting, identifying the caller to you. Specific telephones are programmed to receive this information in Administration programming. For more information see the Programming chapter in the *Compact DR5 System Coordinator Guide*.

norstar

Compact DR5
Coordinator Guide



Contents

Welcome to Norstar	1
System Coordinator's role	1
Assisting your co-workers	2
Your Service Representative	2
Enhanced Transfer	2
Call Display services	3
<hr/>	
Programming	13
How to do programming	13
Planning	13
Programming tools	15
Administration overview	16
Administration headings	16
Entering Administration	18
Exiting Administration	18
Moving through Administration	19
Using the Overlay	20
The Norstar display buttons	22
Programming details	23
System Speed Dial	25
Names	29
Time and date	32
Direct-Dial	35
Capabilities	36
Dialing Filters	36
Telephone (Set) abilities	40
Line abilities	45
Class of Service (COS) passwords	45
Service Modes	48
Password	52
Log Defaults	53
Call Services	54
Auto Call Info	54
Telephone (Set) Services	55
Voice Message Center telephone numbers	56
Voice Message Center lines	5 6
Copying settings	57

Line programming	57
Telephone programming	57
Capabilities programming	57
Programming reminders	58
Norstar telephones	59
Prime telephone	60
Page zones	60
Line Pools	60
Miscellaneous programming	60
Call Pickup Groups	61
Service Modes	62

Telephone features	63
Using Norstar features	64
Answering the telephone	67
Related features	68
What line indicators mean	69
Rings you may hear	69
Displays	69
Prime telephone displays	72
Notes	73
Autodial	74
Displays	74
Notes	76
Call Forward	77
Related features	78
Displays	78
Notes	79
Call information	80
Related features	81
Displays	81
Notes	81
Call Log	82
Related features	88
Displays	88
Notes	91
Call Park	92
Displays	92
Notes	93
Call Pickup	94
Displays	94

Notes	95
Call Queuing	97
Notes	97
Camp On	98
Related features	98
Displays	98
Notes	99
Conference	100
Displays	102
Notes	103
COS Password	104
Displays	104
Notes	104
Customizing your telephone	105
Related features	111
Dialing	112
Related features	113
Displays	114
Notes	116
Do Not Disturb	117
Displays	117
Notes	117
Feature Programming	118
Displays	119
Notes	120
Group Listen	121
Displays	121
Notes	121
Handsfree/Mute	122
Notes	123
Hold	124
Notes	125
Host System Signaling	126
Host system signaling codes	126
Displays	128
Notes	128
Line Pools	129
Displays	129
Notes	130
Messages	131
Related features	133

D i s p l a y s	133
Notes	136
Norstar Telephones	137
B u t t o n s	137
Headset	139
Hearing Aid Compatibility	140
Wall Mounting	140
Page	141
Related features	1 4 1
D i s p l a y s	1 4 2
Notes	142
Priority Call	143
Displays	143
Notes	144
Service Modes	145
Displays	145
Notes	146
Special Telephones ,	147
Speed Dial	150
Displays	151
Notes	152
System features	153
System Speed Dial	156
Time features	157
Displays	157
Transfer	158
Displays	159
Notes	161
Voice Call	162
Displays	163
Notes	163

User cards	165
------------	------------

Glossary	191
----------	------------

Index	207
-------	------------

Welcome to Norstar

In addition to basic telephone service, your **Norstar** digital key system has many extra features that will greatly improve your office communications,

Please take the time to read this guide. It will help you to learn the various tasks which a System Coordinator should perform. This guide also serves as a reference when you assist co-workers to become familiar with **Norstar** features.

When a telephone system is first installed, it takes a bit of time to settle into using new equipment. **Norstar** minimizes this orientation by providing straightforward features and simple instructions.

System Coordinator's role'

The System Coordinator plays an important role in customizing **Norstar** to suit the organization and updating information as the office grows and changes.

Norstar can be customized at three levels:

Personal programming

Personal programming is done by individual telephone users who wish to personalize their **Norstar** telephones by programming features and telephone numbers onto specific memory buttons.

Administration programming

Administration programming is done by the System Coordinator, when you want to change various system-wide settings, as well as some specific settings for each line or telephone.

Configuration programming

Configuration programming is usually done for you by the Installer or Service Representative when **Norstar** is being installed. Specific system-wide parameters are set up in Configuration.

Assisting your co-workers

It is human nature to ask someone how to do something rather than read a user guide. The System Coordinator may be asked to demonstrate to co-workers how to select and use Norstar features. To help you prepare for that possibility:

- Familiarize **yourself** with the procedures for using Norstar features. Examine the components of your Norstar system, identifying the buttons on the different types of Norstar telephones. Read the Telephone User Cards chapter of this Guide for more information on each telephone.
- Familiarize yourself with the various programming reminders provided at the end of the Programming chapter of this Guide. Distribute copies of these reminders to your co-workers after filling in information such as System Speed Dial numbers and names.

It is important for everyone in the office to know that you are the System Coordinator and to know when you are available for consultation. You may wish to schedule sessions for small groups or provide individual assistance to co-workers for programming features on their Norstar telephones.

Your Service Representative

Ask your Service Representative for the service department's telephone number, and write it down. If you have problems with your Norstar equipment, telephone your Service Representative. If you have problems with programming or using any of the features, first read the appropriate section of this Guide and try again before calling your Service Representative.

Enhanced Transfer ,

There is a new procedure for using the Transfer feature in this system. If you are upgrading a Norstar Compact system, be sure to familiarize yourself with the new procedure.

Call Display services ,

Most public telephone companies offer Call Display services which provide information about an incoming call. The caller's name, telephone number and in some cases, long distance indication, can be shown on a telephone with a display. Your **Norstar DR5** system uses this information so that you can:

- view incoming call information as well as the **Norstar** line name that receives the call,
- keep a log of incoming call information and,
- view an integrated display that appears when you have received a message from either an internal **Norstar** user or a **Voice Mail** message from an external caller.

Note: You can access Call Display information only if you subscribe to the services offered by your public telephone company, and if you have the appropriate hardware installed. Contact your Service Representative for more information.

Call Display Information

Call Display information may be shown on your telephone display when you answer an incoming call. In addition to the caller's name, telephone number and long distance indicator, if available, your **Norstar** system can display the line name that received the call.

In the case where several users share a line, only one telephone can be designated to automatically receive Call Display information when a call is alerting on that line. If the call is transferred or camped to another telephone, the Call Display information is automatically available to that telephone.

If a line is not administered to automatically deliver Call Display information to a telephone, the user can invoke the Call Information feature (see Telephone Features section) or answer the call to view the information.

Depending on your requirements, Call Display information presents several convenient options.

- When a caller is identified before the call is answered, you can answer using a personal greeting. You can also prepare yourself prior to answering the call by retrieving any relevant documents,, or **otherwise** orienting yourself to the expected discussion,
- The Long Distance indicator alerts you that an incoming call is long distance and may therefore have higher priority.
- If you are unable to immediately attend to an incoming call, you can use the calling information to make a quick note.
- You can shorten the interruption time of a call from a recognized person. For instance, you can quickly answer the call and let the party know that you are busy but will return the call soon.
- A telephone can be programmed to first view either the caller's name or number or line name, For example, an attendant might wish to see the calling number and area code first in order to transfer the call according to sales region. The salesperson's telephone could display the caller's name first so they can answer with a personal greeting.

-
- Call Display information allows you to answer calls on a priority basis, For example:
 - | If several calls are alerting at your telephone at the same time, you can request information about the calls to decide which one may be more important.
 - | If you are already on a call, information about a second call starting to alert at your telephone can help you to decide whether to answer the second call or remain connected to the first call.
 - If you are in a meeting, the information associated with an incoming call can help you determine if the call is important enough to interrupt the meeting.
 - | If you have several calls on hold and wish to identify the callers, you can view the Call Display information associated with each of the calls to help you determine which one you will respond to first.

Programming tips

In order for the designated telephone to automatically receive Call Display information, it must be programmed to ring for incoming calls on that line.

Before programming Call Display information you may wish to consider the following:

- which individual would benefit the most from automatically receiving Call Display information on an alerting line?
- how are calls routed and what information is the most important to know before a call is answered? For instance, if certain lines are private to individuals, an attendant might wish to first view the line name to determine who the incoming call is for.

Call Log

The Norstar Call Log feature uses incoming Call Display information to make a record of call details for follow-up. Call Log also records several other useful facts such as the time and date of the log entry, the number of repeated calls by the same caller and which telephone answered the call if it was subsequently rerouted and handled by someone else in the **Norstar** system.

When the volume of incoming calls exceeds the ability of employees to handle all calls, or when staff are unavailable to answer calls, Call Log provides a convenient means of capturing information about missed calls.

When connected to a call that has Call Display information, the **Logit** feature of Call Log can be used to provide a quick and accurate means of recording the caller's information for future use (see Telephone Features for more information).

Programming tips

Call Log space can be assigned to individual telephones according to how much space you wish to allocate to each user.

In order to maximize the value of Call Logs and avoid confusion for the end user and their customers, it is important to consider the following when configuring Call Log:

#1 Application of Call Log

Does the user want to return customer calls, track the numbers of calls unanswered, keep a record of most commonly called numbers, etc.?

#2 Who is most interested in logging calls on a particular line?

For instance, dentists working in a clinic may have an individual line assigned to them but prefer that the receptionist handle all of the calls logged on their line.

We strongly recommend that you, limit the number of users logging calls for the same line, as this would be confusing. For example, if two users are logging calls for the same line, they do not know who the call was originally intended for nor are both Call Logs updated when one of the users returns a customer's call. Potentially a customer could be called back twice,

There are few situations where the same call needs to be toggled at more than one set. —

Recommended configuration 1

All lines appear at the Attendant Position, Incoming calls are first answered on the Attendant's set and then transferred to the required destination.

The Attendant wants to track all calls unanswered on the system, during working hours and after hours. The users want to capture in their Call Log, any calls which they did not answer at their set and be able to return those calls from the log.

The Attendant Position logs No **one** answered on all lines and the users log calls Unanswered **by me**. In this configuration the user will log calls transferred to them via intercom (I/C) from the attendant or another user, even though the administration setting is (**Logging Set: N**). Thus the entries in their Call Log are specifically meant for them.

8 / Call Display services

Call Logs with an Attendant Position

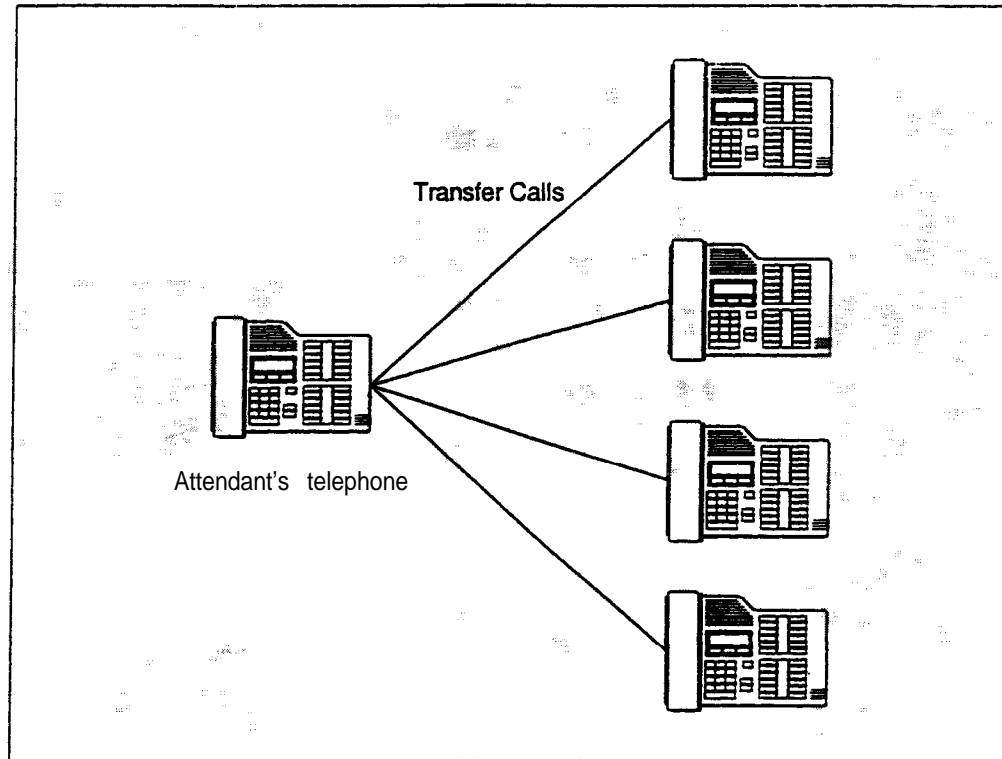

Programming:

Attendant Position

Configuration:

Line Access

Line Assignment
(all lines to appear at
the Attendant's set)

Ringing

Administration:

Log Defaults

Space/Log: (assign log space
to all sets for example, 25.)

Set Services

Logging Set: Y

Set Programming:

* 8 4 (No one answered)

Set Users

Administration:

Set Services

Logging Set: N (no lines assigned)

Set Programming:

* 8 4 (Unanswered by me)

Recommended **configuration 2**

Each **Norstar** user has a unique line appearing at their set. The users have a variety of requirements in terms of logging calls. Using **Feature** the users can program logging capabilities specifically for their sets.

Call Logs with dedicated lines

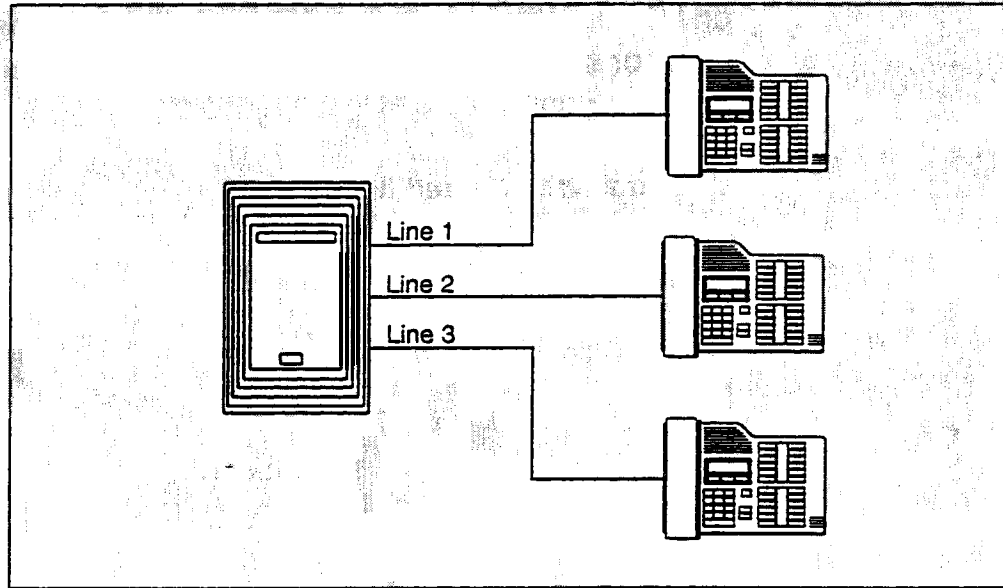

Programming:

Configuration:

- Line Access
- Line Assignment
- Ringing

Administration:

- Log Defaults
- Space/Log: #**
- Set Services
- Logging Set: Y**

Set Programming:

Feature

(No one answered, Unanswered by me, Log all Calls, No autologging).

Recommended configuration 3

The Not-star system has lines 1 and 2 appearing on all sets. The supervisor wants to log all calls for lines 1 and 2 at his/her set in order to analyze call traffic. Two users have been selected to return unanswered customer calls; To avoid confusion when logging and sharing lines, one user logs No one answered calls on line 1 and a second user logs No one answered calls on line 2. This clearly identifies who is responsible for returning calls for each line and ensures that only one person calls the customer back,

Call Logs with shared lines

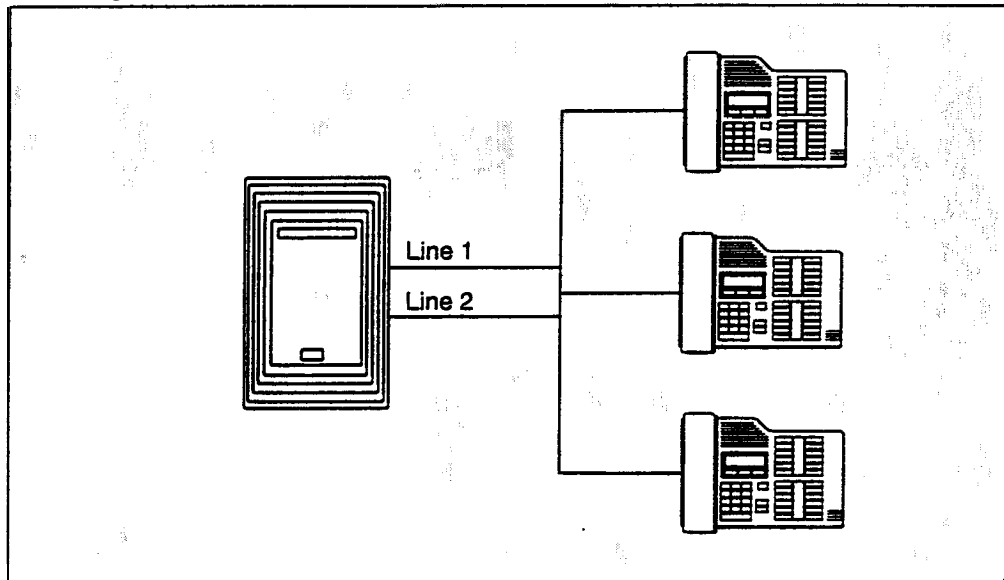

Programming:

Configuration:

Line Access
 Line assignment
 Ringing

Administration:

Log Defaults

Space/Log: #

Set Services

Show Set: 21 (supervisor's set)

Logging Set:

Lines **001 & 002 Y**

Show Set: 22

Logging Set: Line 001 Y

Show Set: 23

Logging Set: Line 002 Y

Set programming:

Set 21 * 8 4 Log All Calls

Set 22 and 23 * 8 4 No one answered

Note: For more information, see the Call tog Feature Card.

Message

Waiting

Norstar Message Waiting allows you to send and receive internal messages as well as maintain a record of your messages. If you have subscribed to Voice Mail Messaging (provided by your public telephone company), and visual message waiting indication is available, Message Waiting also informs you if you have messages at your Voice Message Center and allows you to:

- receive a visual indication that you have messages waiting,
- call your Voice Message Center to hear your messages and,
- clear the message waiting indication from your display.

Programming tips

In order for a telephone to use this feature, it must have a line appearance and Message Waiting must be activated for that line by your public telephone company.

It is possible for two or more telephones to share a line appearance. You must determine if one, some or all of the users sharing a line will receive Message Waiting notification. If it is a sub-group, such as a sales team within a company, it may be appropriate to share the feature providing that the users have an agreed upon procedure for retrieving and deleting messages.

For further information on Call Information, Call Log and Messages, see the Telephone features section. Programming actions are described in further detail in the Programming section.

telemanuals.com

Programming

The system comes programmed with default settings that may be sufficient initially. Administration programming is performed by the System Coordinator, and lets you change settings that probably have to be updated regularly **because of** staff turnover or new business **contacts**. You can also assign some features to **individual lines** and **telephones**. This provides you with real flexibility in making your telephones work together.

This chapter contains detailed **procedures** for programming System Speed Dial codes, Names for lines and telephones, and Time and Date information. If you are new to Administration programming, you may want to get comfortable with these three procedures before attempting other procedures.

Personal programming does not follow the same procedures as Administration programming. Personal programming allows you to assign a particular function to some of the keys, and is unique to each telephone. For more information on Personal programming, see the Feature programming description in the Telephone features chapter.

How to do programming

The system is programmed using a M7208, **M7324** or M7310 Telephone. Use the buttons on the telephone to program a setting or to request a specific programming action.

Norstar guides you step by step on the telephone display while you enter programming, select and change what you want, and exit programming.

Planning

Only one Not-star telephone can access Administration programming at a time. While programming a telephone, you cannot use it to make or receive calls. While you are programming, other users of the Norstar system may use their telephones, but cannot program any memory keys.

Determine programming requirements

Read about the available programming settings in this chapter, then determine how your co-workers would like the features programmed.

Get the following information:

- the numbers of the installed lines,
- the internal telephone numbers of installed **Norstar** telephones,
- the telephone numbers to be programmed into System Speed Dial,
- the names for lines and telephones,
- the lines and internal numbers that are subject to Line abilities and Set abilities programming,
- the required Filters,
- the Set Abilities to be assigned to individual telephones,
- how the system should be programmed to optimize the Service Modes feature,
- whether a new Administration password is required, and
- whether Class of Service passwords are required.

Programming tools

A **Norstar** telephone

System programming can be performed on an M7208, M7310 or M7324 Telephone.

The **Norstar** Programming Overlay

The *Norstar Programming Overlay* is a paper cutout that labels telephone buttons used during programming. This makes it easier for you to 'recognize the button that you want.'

The *Norstar Programming Overlay* for the M7208 Telephone is placed over all of the eight buttons. The Programming Overlay for the M7310 and M7324 Telephones is placed over the top four memory buttons with indicators. The *Norstar Programming Overlays* are provided at the end of this book.

The Compact **DR5** Programming Record

The *Compact DR5 Programming Record* provides a convenient way to record what you have programmed. It also helps you to plan your programming. Settings are grouped according to their function.

Pages from the Record may be photocopied as necessary for programming many telephones or lines.

The **Norstar** Telephone User Cards

Each **Norstar** telephone has a *Norstar Telephone User Card* that lists the most commonly used features.

The Compact **DR5** Telephone Feature Card

The *Compact DR5 Telephone Feature Card* lists the features that can be accessed with the button.

Administration overview

Administration programming lets you change settings for the entire **Norstar** system, as well as settings for individual telephones and external lines.

Pre-programmed default settings may initially be sufficient for your needs. You can use Administration programming to customize your Nor-star system by changing these default settings. In this section, default options are shown in bold type.

The defaults correspond to those assigned during **Norstar** installation. The option you see while programming may be different if that setting has been changed. If the display shows a line number or internal number during programming, an example is shown in the Administration procedures.

Administration headings

Headings and subheadings in Administration programming help you to keep track of where you are. An example of a heading is **1.Sys speed** dial for programming System Speed Dial. When you program a System Speed Dial number, **Display digits** is displayed as a subheading.

Administration programming has nine headings:

ADMINISTRATION CODE



Password:



1. Sys speed dial



2



3. Time and date



4. Direct-Dial



5. Capabilities



6. Service Modes



7. Password



8. Log Defaults



9. Call Services

System Speed Dial assigns a two-digit code (01-70) for fast dialing of up to 70 telephone numbers from any Norstar telephone.

Names identifies external lines and telephones by name.

Time and Date adjusts the time and date displayed on each Norstar telephone.

Direct-Dial designates the telephone that can be reached by dialing a single digit.

Capabilities defines dialing filters, line abilities and telephone abilities. It assigns restrictions and capabilities to Class of Service (COS) passwords, to telephones, to lines and to line/telephone combinations.

Service Modes controls how the Norstar system responds to calls, depending on the time of day.

Password changes the password that controls access to Administration programming.

Log Defaults reallocates the Call Log space for all telephones in the system.

Call Services customizes the use of Call Display information at your telephone.

Entering Administration

When your system is first installed, there is no password stored in the **Norstar** system. You are not prompted to enter a password as you enter Administration for the first time unless your Customer Service representative has already programmed one for your system.

To Enter Administration:

1. Release all calls on your telephone.

2. Enter the Administration access code:

Feature * * 2 3 6 4 6 which is also
Feature * * A D M I N .

3. If the display changes to Password: , enter the Administration password. (The password is not shown on the display as you enter it.)

If the password is correct, the display shows **1. Sys speed** dial , and three triangular indicators ► are shown on the vertical display.

If the password is incorrect, the display does not change. Check the password. Press **RETRY** and re-enter the password.

4. Place the **Norstar** Programming **Overlay** over the buttons.

Exiting Administration

Norstar stores your changes automatically as soon as you alter any settings; you do not need to “save” your changes.

1. Press **Ris**.

The display briefly shows *End of session*.

Moving through Administration

To program a setting, you must first locate the correct heading. To do this, scan through the headings of Administration using the and buttons.

To **move** through **Administration** headings:
After entering Administration, the display shows

1. Sys speed dial.

1. Press .
The display shows **2. Names**
 2. Press .
The display shows **3. Time and date.**
 3. Press .
The display shows **4. Direct-Dial.**
 4. Press .
The display shows **5. Capabilities.**
 5. Press .
The display shows **6. Service Modes.**
 6. Press .
The display shows **7. Password.**
 7. Press .
The display shows **8. Log Defaults.**
 8. Press .
 9. Press .
- The display shows **1. Sys speed dial.**

Using the Overlay

The indicators show which buttons can be used at that programming step. The functions on these buttons allow you to move through the headings and subheadings of Norstar programming.

Heading

moves up in the hierarchy of headings and subheadings.

Show

moves down in the hierarchy of headings and subheadings, or to begin programming settings under a heading or subheading,

Next

moves to the next heading, subheading, or programmable setting.

Back

moves to the previous heading, subheading, or programmable setting.

Some of the functions identified on the Programming Overlay for the M7208 Telephone are available on display buttons on M7310 and M7324 Telephones. For information about the additional functions on the M7208 Telephone overlay, see the section in this chapter entitled The **Norstar** display buttons.

Programming Overlay for the M7208 Telephone (top) and for the M7310 and M7324 Telephone (bottom)

M7208 Programming Overlay

<input type="checkbox"/>	Copy Yes
<input type="checkbox"/>	Backspace No
<input type="checkbox"/>	Change Remove
<input type="checkbox"/>	Add Default
<input type="checkbox"/>	Heading Retry
<input type="checkbox"/>	Show <--View-->
<input type="checkbox"/>	Back
<input type="checkbox"/>	Next OK

Norstar Programming Overlay

Heading	<input type="checkbox"/>	<input type="checkbox"/>	<input type="checkbox"/>	Show
Back	<input type="checkbox"/>	<input type="checkbox"/>	<input type="checkbox"/>	Next

The Norstar display buttons

Display buttons perform many functions. Depending on where you are in programming, one, two, or three display buttons may be available, at any one time. Press one of the display buttons to select the function that you want.

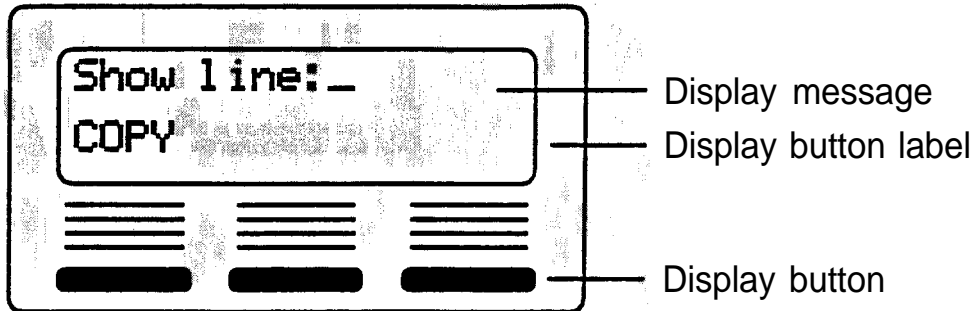

The most common display button labels are:

- CHANGE** changes a programmable setting.
- BKSP** moves the cursor one space backward (backspace) and delete a character, allowing you to re-enter a number or letter.
- COPY** copies line or telephone programming.
- VIEW→** shows the last part of a displayed message longer than 16 characters.
- ←VIEW** shows the first part of a displayed message longer than 16 characters.
- >** moves the cursor one position to the right when programming a name.
- <--** moves the cursor one position to the left when programming a name.

Programming details

Entering numbers

Numbers are entered from the Norstar telephone dial pad. The **BKSP** display button may be used to edit the number.

Line numbers must always be entered as a two-digit number with a leading zero. Internal telephone numbers, also referred to as Directory Numbers (DNs), are always two-digits long.

Viewing long telephone numbers

External telephone numbers can be up to 24 digits, but the telephone display is only 16 character spaces long. If you wish to see a previously programmed number that is longer than 16 digits, you must do the following:

Begin, for example, with **123456789012345....**

The display shows **only the** first 15 digits. The three dots (...) at the end of the display indicate that more digits remain to be displayed for the external number.

1. To see the remaining digits, press **VIEW→**.
2. To see the first 15 digits again, press **←VIEW**.

Entering names

Letters and numbers can be entered as part of a name for various settings. The method of entering a name is always the **same**.

Begin with a **setting** that prompts you to enter a name. The display shows a **cursor** (**_**) to indicate where you can enter the **next** character; **To enter a name:**

1. Press the **button** on the dial pad with the printed letter or number that you want.

Each time that you press the button, a new character is shown on the display. For example, the button for the number 3 has the letters D, E, and F, where:

D is shown after the first press

E is shown after the second press

F is shown **after** the third press

3 is shown **after** the fourth press

D is shown' again after the fifth press.

(Letters are always shown in upper case.)

2. When the character that you want is displayed, press **→** or **#** to move the cursor to the next character position.

OR

if you want to correct a character entered by mistake,

press **←** or ***** until the cursor is positioned beneath the character that you want to correct.

OR

If you want to **move** the cursor back and delete a character, press **BKSP**.

3. Repeat step 1 for the remaining characters.

System Speed Dial

The System Speed Dial programming section allows you to set the Speed Dial codes for external telephone numbers which the people in your office use most often. Use the Personal Speed Dial feature to program numbers used by only one or two people.

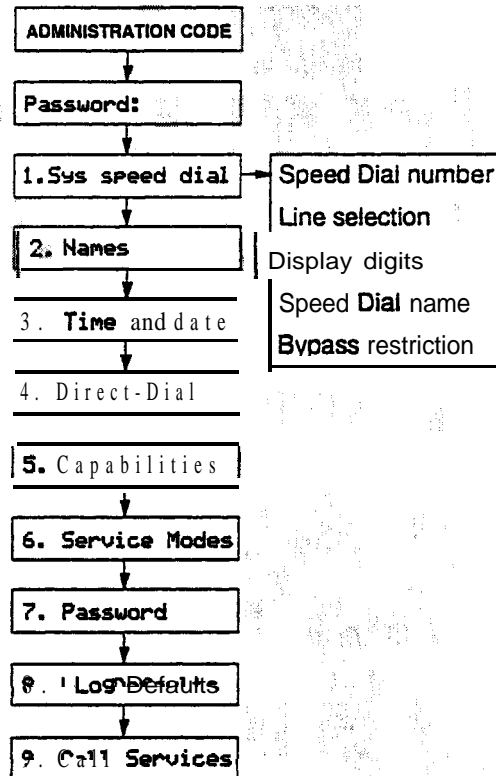

You can program 70 System Speed Dial codes ranging from #01 to #70.

System Speed Dial Number

System Speed Dial Number lets you assign a System Speed Dial telephone number to a two-digit code. The System Speed Dial Number may contain 24 digits.

Begin with the display showing 1. **Sys speed** dial.

1. Press **Show**.

The display shows **Speed dial #: _**.

2. Select the Speed Dial code you want to program:
Press **Next** until the display shows the correct code.

OR

Enter the Speed Dial code on the dial pad.

Note: To assign default settings, press **DEFAULT** and then press **Next** to go to the next Speed Dial code.

3. Press **Show**.

4. Press **CHANGE**.

For example, the display may show **#05: _**.

5. Enter the new telephone number from the dial pad, including all digits such as an initial **9** or an area code that must be dialed to call the number manually. If you need to backspace the cursor, press the **BKSP** display button.

For example, press **5 5 5 1 2 3 4**.

The display shows 5551234.

6. Press **OK** to store the System Speed Dial number.

Programming hints

A Host System Signaling feature code may be inserted into the System Speed Dial number. Run/Stop and Pause each use one character position; and Link, Timed Release, and Programmed Release each use two positions.

For more information on using these features in System Speed Dial programming, see the Host System Signaling section in the Telephones features chapter.

Line Selection

Line Selection allows you to specify the external line that is used for a System Speed Dial number. The options are the Prime line, an external line, or a line pool.

After you have programmed a System Speed Dial number, press **Next** and the display shows:

Use **Prime 1 line**

OR

Use **1 line: 62**, for example, if a line is already assigned

OR

Pool code: 42, for example, if a line pool access code is already assigned.

1. To change the setting, press **CHANGE** until the display shows the option to be programmed.
2. If you select a line number or a line pool access code, enter the digits from the dial pad. A line pool access code can be from one to four digits long.

Display Digits

Display Digits determines whether the telephone number is displayed when a System Speed Dial number is used, or whether a name associated with that number is displayed.

After you have programmed a line selection for a System Speed Dial number, press **Next** and the display shows **Display digits:Y**.

1. Press **CHANGE** to change the setting. Options are Y (Yes) and N (No).

System Speed Dial Name

System Speed Dial Name allows you to assign a name to the stored System Speed Dial number. When the Display Digits setting is "No", the programmed name is shown on the Norstar display when the System Speed Dial feature is used.

The name can be up to 16 characters long. The default name is the System Speed Dial number; for example, **Sys Spd Dial 02** for System Speed Dial code 02.

After programming Display digits to N, press and the display shows Name.

1. Press .
The display shows the assigned or default name.
2. Press **CHANGE**.
3. Enter the first character of the name by pressing the appropriate dial pad button one, two, three, or four times. For more information, see the section in this chapter entitled Entering names.
4. To move the cursor to the next position, press **-->**.
Continue entering characters.

Programming hints

You can program System Speed Dial Name only if Display Digits is set to No.

Bypass Restrictions

Bypass Restrictions allows the System Speed Dial number to bypass any restrictions in applied Dialing filters. Dialing filters are programmed in the Capabilities section of Administration programming.

After programming the System Speed Dial Name, press and the display shows **BYPASS restr'n: N**.

1. Press **CHANGE** to change the setting. Options are N (No), and Y (Yes).

Names

You can assign names to identify external lines and your co-workers' telephones. During a call, the name (if programmed) is shown on the telephone display instead of the external line number or internal telephone number of the caller.

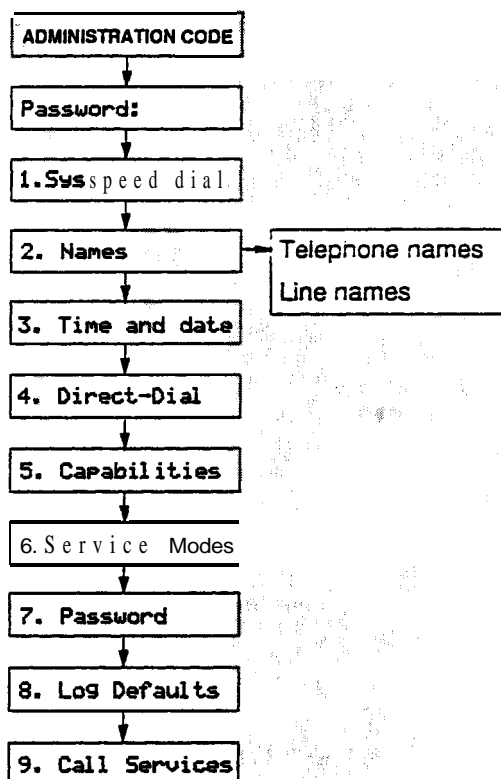

Programming hints

Telephone names and line names can contain both letters and numbers, but cannot be longer than seven characters. The # and * symbols cannot be used.

You can give the same name to two or more telephones, or to a telephone and a line in your system. To avoid confusion, you should avoid such duplication. Use initials, abbreviations, or even nicknames to give each telephone a unique name.

Two lines cannot have the same name. If you enter a line name which has already been used, you hear an error tone, and the display shows Use unique **name**.

Telephone Names

Personalize your office communication by assigning names to the telephones in the Norstar system. A telephone's default name is its internal number, for example, 27.

Begin with the display showing **1. Sys speed dial.**

1. Press .
The display shows **2. Names:**
2. Press twice.
The display shows **Show set: --.**
3. Enter the internal number of the telephone.
OR
Press for the name of the telephone with the first internal number.
4. Press **CHANGE**.
The name is removed from the display, and a cursor is shown.
5. Enter the first character of the name by pressing the appropriate dial pad button one, two, three, or four times. For more information, see the section in this chapter entitled Entering names.

Note: Press to restore the default name and go to the next internal number.
6. Press **-->** to move the cursor to the next position.
Continue entering characters.

Programming hints

If Automatic Telephone Relocation is turned ON, the name and internal number of a telephone are saved if the telephone is moved within your system.

Line Names

Line Names allows you to assign a name to an external line. The default name is the line number, for example, Line 02.

Begin with the display showing 1. **Sys** speed dial .

1. Press .

The display shows 2. **Names**.

2. Press .

The display shows **Set names**.

3. Press .

The display shows Line **names**.

4. Press .

The display shows Show 1 **line: _**.

5. Enter the line number from the dial pad.

OR

Press to program the name of line 01.

6. Press **CHANGE**.

The name is removed from the display, and a cursor is shown.

7. Enter the first character of the name by pressing the appropriate dial pad button one, two, three, or four times. For more information, see the section in this chapter entitled Entering names.

Note: Press to restore the default name and go to the next external line.

8. Press **-->** to move the cursor to the next position.

Continue entering characters.

Time and date

Time and date programming allows you to set the time and date which is shown on the display when a telephone is not in use. As with any clock, this needs to be done every time that your office has a power failure;

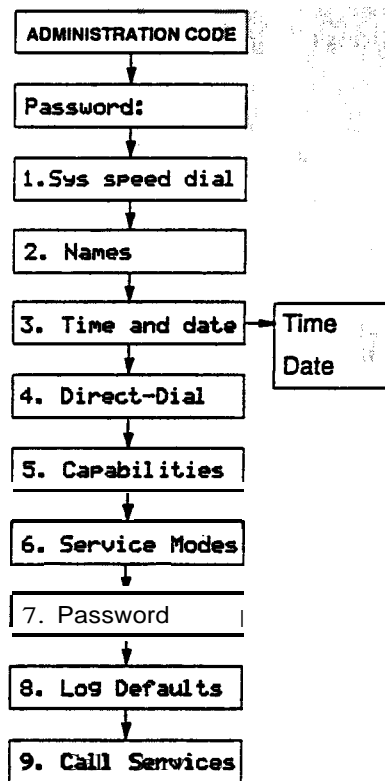

Changing the time and date is easy, but there are a couple of things to remember:

- All times and dates must be entered using numerals. For example, February would be entered as “2”.
- The time may be entered in either 12 or 24-hour format. If the display is in English, and the hour entered is less than thirteen, the display prompts you to specify “am” or “pm”.
- The year is not shown on the telephone display, but make sure that it is set correctly. Norstar is programmed to allow for leap years.

English language displays always show the time in 12-hour format, while the alternate language displays always use the 24-hour format.

Setting the time

Begin with the display showing 1. **Sys speed dial** .

1. Press **Next** twice.
The display shows 3. Time and date,
2. Press **Show** .
The display shows the time, for example, Time **01:00**.
3. Press **CHANGE** .
The display shows the hour, for example, **Hour:01**.
4. Set the hour.
 - a. Press **CHANGE** .
A cursor replaces the number on the display.
 - b. Enter the hour using the dial pad.
For example, press **0 9** .
 - c. Press **Next** .
The display shows the minutes, for example, **Minutes: 00**.
5. Set the minutes.
 - a. Press **CHANGE** .
A cursor replaces the number on the display.
 - b. Enter the minutes using the dial pad.
For example, press **1 5** .
 - c. Press **Next** .
If the hour entered in step 5 is less than thirteen, the display shows **am** .
6. To switch the message to PM , press **CHRNGE** .
To switch it back to am , press **CHANGE** again.
7. To set the date, press **[Next]** .

Setting the date

Begin with the display showing **1.595 speed** dial .

1. Press twice.
The display shows **3.Time** and **date.**
2. Press .
- The display shows the time, for example, Time **01:00.**
3. Press .
- The display shows the date, for example, Date **31 Mar 91.**
4. Press **CHANGE**. The display shows Year: 88.
5. Set the year.
 - a. Press **CHANGE**.
A cursor replaces the number on the display.
 - b. Enter the year using the dial pad.
For example, press enter the year 1990.
 - c. Press .
 - The display shows the month, for example **Month: 81.**
6. Set the month.
 - a. Press **CHANGE**.
A cursor replaces the number on the display.
 - b. Enter the month using the dial pad.
For example, press to enter February.
 - c. Press .
 - The display shows the day, for example **Day: 81.**
7. Set the date.
 - a. Press **CHANGE**.
A cursor replaces the number on the display.
 - b. Enter the date using the dial pad.
For example, press .

Direct-Dial

Direct-Dial programming allows you to call the Direct-Dial telephone assigned to your telephone by dialing a single digit. Use the **Direct-Dial** heading to specify the telephone directory number (DN) designated as the Direct-Dial telephone.

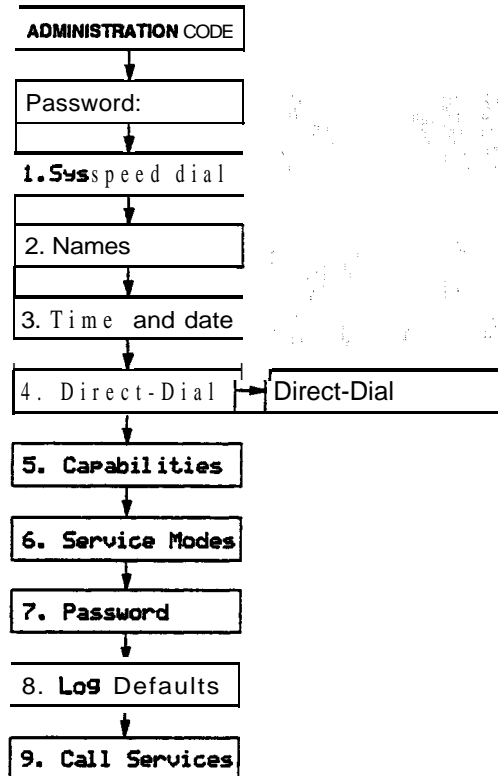

Use the **Show** button, the **CHANGE** display button and the dial pad to enter the internal number of the telephone to be designated as the Direct-Dial telephone.

Programming hints

To complete Direct-Dial telephone programming, assign a Direct-Dial telephone to each telephone in the system using the Capabilities section of Administration programming.

The digit you dial in order to get the Direct-Dial telephone to ring can be programmed by your Customer Service representative.

Capabilities

Capabilities programming assigns restrictions and exceptions to Class of Service (COS) passwords, telephones, and lines.

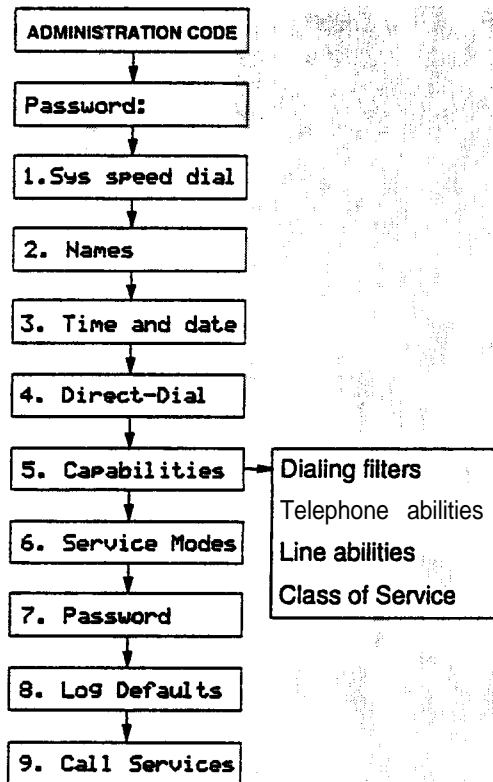

Dialing Filters

A dialing filter is made up of restrictions and exceptions. These specify the external numbers which can or cannot be dialed from a telephone or on a line.

After dialing filters are defined, they may be used as telephone (set) filters, line filters and line/set filters to manage outgoing calls.

Use the **Show** button, the **ADD** display button, the dial pad, and the **OK** display button to program the restrictions and exceptions for each dialing filter.

For example

You may need filters for three different types of users:

- Managers may require unrestricted dialing.
- Secretaries may need to be limited to calls on line 003 to the West coast office only.
- Clerks may need to be limited to calling specific area codes and the West coast office:

Dialing filters are most commonly used to prevent unauthorized long-distance calls, without restricting local calls. Dialing filters restrict the numbers that an internal user can dial on external lines.

If a line/set filter has been defined for the line selected at the user's telephone, it overrides any line filters or telephone filters which might otherwise apply.

If no line/set filters have been defined, dialed digits are filtered through (and may be rejected by either of) the telephone filter (if defined) and the line filter (if defined).

 Programming hints

- **Norstar** can have up to 24 dialing filters (00 to 23).
- Filter 00 cannot be changed.
- Each programmable filter can have up to 48 restrictions; there is no limit on the number of exceptions that can be allocated to any restriction. ,
- There is a maximum of 200 restrictions and exceptions allocated to the 23 programmable filters. For example, notice the reduction in the number of available restrictions and exceptions after each filter has been programmed.

Filter	User type	Rest's	Excep's	Remaining
00	manager	--	--	200
01	secretary	5	5	190
02	clerk	7	12	171
Total		12	17	(200 - 12 - 17 = 171)

- The maximum length for a restriction is 15 digits; for an exception, the maximum is 16 digits.
- The asterisk * is a “wild card” that stands for any digit.
- Any restriction or exception can be used in any number of filters. Each time it is used, it counts as one entry. For example, if restriction 411 exists in filters 01, 02 and 03 it uses up three entries of the 200 entries available.
- Removing a restriction also removes the exceptions associated with it, and changes the identifying number of the restriction. For example, removal of restriction 01 renumbers restrictions 01 to 48 as 01 to 47.

Note: The removal of a restriction from one dialing filter has no effect on the contents of other filters into which the restriction was copied.

- You cannot delete a filter. Removing the restrictions programmed on a filter makes it an unrestricted filter but the filter is not removed.

Filter descriptions

- Filter 00 permits unrestricted dialing, and cannot be changed.
- Filter 01 is pre-programmed with five restrictions and some associated exceptions.

Filter	Restrictions	Exceptions
00	Unrestricted dialing	
01	0	
	1	1800 1555 1*1*555 1*0*555
	911	911
	411	
	976	
02 - 23	None	

- Filters 02 and 03, although not pre-set with restrictions and exceptions, are the default filter settings used later in programming:

Filter	Where the filter is programmed as a default setting in Capabilities programming	
02	Set abilities	Set filter:
03	Line abilities	Line filter:

Telephone (Set) abilities

Telephone (Set) abilities programming assigns dialing filters and permissions to telephones. Telephone abilities include:

Telephone (set) filters	Page Zone
Line/telephone filters	Auxiliary Ringer
Telephone Administration Lock,	Direct-dial telephones
Full Handsfree	Call Forward On Busy
Automatic Handsfree	Call Forward No Answer
Handsfree Answerback	Receive tones
Call Pickup Group	Hotline
Paging	Priority Call

Telephone (Set) filter

A Telephone filter is a collection of restrictions and exceptions defined in Dialing filters. These filters are applied to telephones through Set filter programming.

Use the button, the **CHANGE** display button and the dial pad to enter the number of the Dialing filter to be assigned as the Telephone filter. Filter 02 is the default set filter.

Line/telephone (Line/set) filter

A Line/telephone dialing filter is applied to the appearance of a line at a **specific** telephone. This type of filter replaces any Line or Telephone filters which might otherwise apply.

Line/set filters control the numbers that may be dialed on specific external lines from specific telephones. For example, a Line/set filter can permit a call to a specific long-distance number on line 03 from a specific telephone, but no other long-distance numbers, and on no other line.

Use the [Show] button, the **CHANGE** display button and the dial pad to enter the number of the Dialing filter to be assigned as the Line/telephone filter.

Programming hints

- Up to 24 filters may be defined in the system (filters 00 to 23). Line/set filters fall under this limitation.
- A maximum of 255 Line/set dialing filters may be applied to lines at telephones.

Telephone* Administration **Lock**

Telephone Administration Lock limits the types of features that may be used or programmed at a telephone. Use the **CHANGE** display button to select one of the three options: None, Partial and Full.

None allows you to access any feature on your telephone.

Partial prevents:

- programming **Autodial** buttons
- programming Personal Speed Dial numbers
- programming feature buttons
- moving line buttons
- changing the display language
- changing Dialing Modes (Automatic Dial, Pre-Dial, and Standard Dial)
- using Voice Call Deny
- using Administration programming
- saving a number with Saved Number Redial

Full, in addition to the restrictions outlined for Partial lock, prevents:

- changing Background Music
- changing Privacy
- changing Do Not Disturb
- using Ring Again
- using Call Forward all calls
- using Send Message
- using Trunk Answer
- activating Service Modes

Full Handsfree

Full Handsfree allows you to make or receive calls without picking up the receiver, and allows a headset to be used with the Norstar telephone. Use the **CHANGE** display button to select the setting: N (No) or Y (Yes).

Programming hints

A **Handsfree** button is automatically assigned to a telephone that is programmed with Full Handsfree. Full Handsfree is always disabled for an M7100 Telephone.

Automatic Handsfree

Automatic Handsfree activates the Handsfree microphone and speaker when you make or receive calls by pressing a line button. Use the **CHANGE** display button to select the setting: N (No) or Y (Yes).

Programming hints

You can program Automatic Handsfree only if the telephone has Full Handsfree set to Yes.

Handsfree Answerback

Handsfree Answerback allows you to answer a Voice Call without lifting the receiver. Use the **CHANGE** display button to select the setting: **Y** (Yes) or N (No).

Programming hints

Handsfree Answerback is always disabled for an M7100 Telephone.

Call Pickup (Group)

Each telephone can be assigned to one of up to nine Call Pickup groups. Members of a Call Pickup group can answer any calls ringing at a telephone in the group. Use the **CHANGE** display button to select the setting: NO, 1, 2, 3, 4, 5, 6, 7, 8, or 9.

Programming hints

You cannot pick up a call that is on a Private line, or a call that is ringing only the Auxiliary Ringer.

Paging

This setting determines whether a telephone has access to the Page feature. Use the **CHANGE** display button to select the setting: Y (Yes) or N (No).

Page zone

Each telephone can be assigned to one of three zones for receiving Page messages. A zone is any selection of Norstar telephones you want to group together, regardless of location. Use the **CHANGE** display button to select the setting: 1, 2, 3, or **NO**.

Programming hints

You can program Page zone only if the telephone has Paging set to Yes.

Auxiliary Ringer

This setting causes the Auxiliary Ringer (if installed) to ring when the telephone rings. An Auxiliary Ringer is important in noisy environments where a Norstar telephone might otherwise not be heard. Use the **CHANGE** display button to select the setting: N (No) or Y (Yes).

Direct-Dial telephones

A telephone can be assigned to call a Direct-Dial telephone when you dial a single digit. Use the **CHANGE** display button to select the setting: **Set1** or None.

Programming hints

Any number of telephones can be assigned to call a particular Direct-Dial telephone.

The digit you dial in order to get the Direct-Dial telephone to ring can be programmed by your Customer Service representative.

Call Forward On Busy

Call Forward On Busy redirects an incoming call to another telephone on your Norstar system when you are busy on a call, or when you have Do Not Disturb activated at your telephone.

Use the **(Show)** button, the **CHANGE** display button, and the dial pad to program the internal number of the telephone that your calls are to be directed to.

Call Forward No Answer

Call Forward No Answer lets you redirect an incoming call to another telephone on your Norstar system when the call is not answered at your telephone.”

Use the **Show** button, the **CHANGE** display button, and the dial pad to program the internal number of the telephone that your calls are to be directed to.’

Forward No Answer delay

If you assign another telephone to receive your calls, you can also assign the number of times that the incoming call rings before the call is forwarded. To estimate the delay time in seconds, multiply the number of rings by six. Use the **CHANGE** display button to select the setting: 2, 3, 4, 6, or 10 rings.

Receive tones

The Receive tones setting allows the system to accept and relay tones to the internal lines. Tones are required if you want to connect an answering machine or a fax on an internal line. Use the **CHANGE** display button to select the setting: N (No) or Y (Yes).

Hotline

Hotline automatically calls a pre-assigned number when you lift the receiver or press **Handsfree** at your telephone. Hotline has three options: None, internal (**Intrnl**), and external (**Extrnl**).

Internal assigns an internal number.

External assigns an external number. If you select an external number, you can also select the line on which the call is made: the Prime line, an external line, or a line pool. You will have to specify the Line Pool Access code for a line pool.

Use the **CHANGE** display button to select Hotline setting. If you select **Intrnl**, use the **Show** button, the **CHANGE** display button, and the dial pad to program the internal number of the telephone that Hotline calls are to be directed to.

If you select **Externl** , use the [Show] button, the **CHANGE** display button, and the dial pad to program the external telephone number that Hotline calls are to be directed to, and to program the line Hotline calls are to be made on.

Programming hints

The **telephone** should, **be** labeled to inform anyone using it that Hotline is active.

A telephone's Prime fine, line pool access codes, and access to a line pool can be programmed by your Customer Service representative.

· Priority Call

This feature lets you call from your **Norstar** telephone and interrupt calls or override Do Not Disturb on another **Norstar** telephone. Use the **CHANGE** display button to select the setting: N (No) or Y (Yes).

Programming hints

Apply this feature only to telephones from which such interruptions can be justified.

Line abilities

Line abilities programming assigns dialing filters to lines.

Line filter

A Line filter is a collection of restrictions and exceptions defined in a Dialing filter, and applied to an outgoing line. A Line filter on an outgoing line may be used to limit the capabilities of that line to carry calls made to specific area codes or destinations.

Use the **CHANGE** display button, and the dial pad to program the Line filter. Filter 03 is the default Line filter.

Class of Service (COS) passwords

Class of Service (COS) passwords permit controlled access to a system's resources. Class of Service programming defines passwords, their associated dialing filters and user filters.

A Class of Service can be associated with a telephone, a line or a COS password. It determines the dialing capabilities that apply to internal telephones and any lines used for external calls.

Users have a Class of Service associated with their telephones, in the sense that there are dialing filters associated with telephones, as **well as** line **pool** assignments. Use of a COS password affects only the telephone's dialing capabilities.

The ability to change the COS internally means that someone using another person's telephone can temporarily change the restrictions that would normally be applied.

Password security

- Class of Service passwords for a system should be determined randomly, and should be changed on a regular basis.
- System users should memorize their COS passwords instead of writing them down.
- Employees' COS passwords should be deleted when they leave the company.

Programming hints

- A system can have a maximum of 19 six-digit COS passwords (00 to 18).
- You can copy the data from one COS password to another COS password number using the **COPY** display button in the same way that telephone and line data can be copied.
- COS passwords must be unique.

Programming COS passwords

Use the **Show** button, the **CHANGE** display button, and the dial pad to program the six-digit sequences for each password. Use the **BKSP** display button to edit digit sequences you have entered.

User filter

The COS User filter replaces the telephone (set) filter or the line/set filter that would otherwise apply to a specific call.

Use the button, the **CHANGE** display button, and the dial pad to program the two-digit User filter. The default setting (**Deflt**), means that any other filters in place (telephone (set) filter or line/set filter) still apply,

Line filter

The COS Line filter replaces the line filter that would otherwise apply to a specific call.

Use the **CHANGE** display button, and the dial pad to program the two-digit Line filter. The default setting (**Deflt**), means that any Line filter already programmed still applies.

Service Modes

Using Service Modes, you can control how the Norstar system responds to calls, depending on the time of day. Up to three different Service Modes can be programmed, each with unique ringing arrangements.

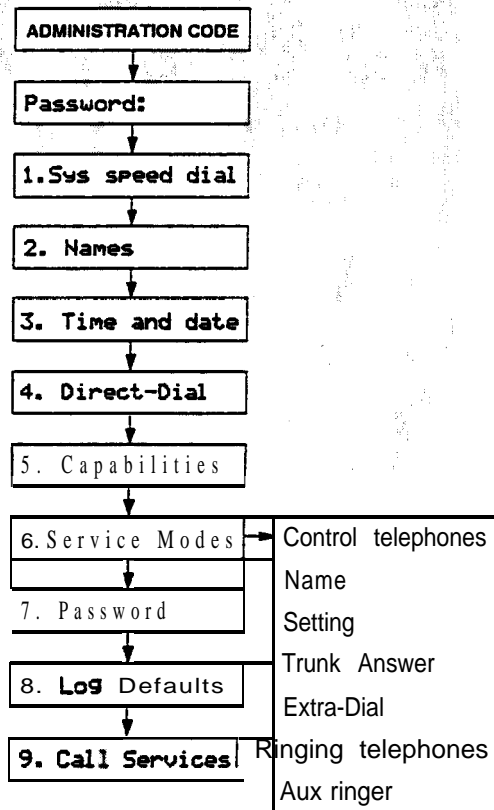

Control telephones

Control telephones are assigned to each external line and are used to control the Service Mode by allowing you to turn the Service Mode ON or OFF for that line.

Use the [Show] button, the **CHANGE** display button, and the dial pad to program the internal number of the Control telephone for each line.

Programming hints

Only the external lines programmed with a Control telephone can be placed into a Service Mode.

You can assign a Control telephone to more than one external line, but a line cannot be assigned to more than one Control telephone.

Only one Service Mode applies at any one time to all external lines controlled by a given Control telephone.

The default Control telephone for all lines is 21.

Service Modes

The three Service Modes are programmed in the same way.

Service Mode Name

The Service Mode Name identifies the active Service Mode, and is shown on the display of the Control telephone when the Service Mode is turned ON.

Use the button, the **CHANGE** display button, and the dial pad to program the Service Mode name. For information on entering names, see the information in this chapter entitled Entering names.

Programming hints

The default names of the three possible Service Modes are only suggestions, and may be changed to any other name.

A Service Mode name can be one to seven characters.

Service Mode setting

The Service Mode setting controls how the Service Mode is turned ON and OFF. Use the **CHANGE** display button to select the setting: Manual, Automatic, or OFF.

Manual allows you to turn the Service Mode ON and OFF at any time from a Control telephone. The Service Modes feature code must be entered at the telephone to access this feature.

Automatic allows you to pre-assign a stop and start time during which the Service Mode is active. You are still able to start and stop the Service Mode by entering the Service Modes feature code at a Control telephone. If you **select this** setting, you will have to program start and stop times. See the section in this chapter on Time and Date for information on programming times.

OFF prevents the Service Mode from being activated.

Programming hints

Overlapping times may be assigned. For example, if Service Mode 1 is assigned from 9:00 am to 4:00 pm and Service Mode 2 is assigned from 1:00 pm to 5:00 pm, then the start time of the second Service Mode is treated as a stop time for the first Service Mode. This is also true if two Service Modes have the same start time but different stop times.

If one Service Mode starts and stops within the times of another Service Mode, the first service temporarily ends when the second service starts. The first service then resumes when the second service has ended.

Default stop and start times correspond to typical hours which may be required for a night Service Mode.

Default Service Mode times

Service Mode	Start time	Stop time
Service Mode 1: Night	23:00	07:00
Service Mode 2: Evening	17:00	23:00
Service Mode 3: Lunch	12:00	13:00

Trunk Answer

Trunk Answer allows you to answer, from any telephone, an external call which is ringing at another telephone in your office. This is useful if the other telephones have not been assigned the same lines as the telephone you are using to answer the call.

You can change the Trunk Answer setting only if the Service Mode is set to Manual or Automatic.

Use the **CHANGE** display button to select the setting: Y (Yes) or N (No).

Extra-Dial telephone

A telephone normally in service as a Direct-Dial telephone, can be programmed in Service Modes to allow internal calls to the Direct-Dial telephone to also ring at the Extra-Dial telephone.

Use the **CHANGE** display button and the dial pad to enter the internal telephone number of the Extra-Dial telephone.

Programming hints

The Extra-dial telephone provides the option of assigning one more Direct-Dial telephone in the **Norstar** system for each operational Service Mode.

Ringing

You can assign additional telephones to ring for incoming calls on each external line. Use the **Show** button, the **ADD** display button and the dial pad to, enter the internal telephone number of the Ringing telephone for each line.

You can indicate whether the Auxiliary Ringer (if installed) also rings. Use the **CHANGE** display button to select the setting: Y (Yes) or N (No).

Programming hints

The default ringing telephone is 21. This means that all lines ring at Control telephone 21, when Service Modes are activated. A Ringing telephone can be assigned to more than one Service Mode.

Password

The Administration password allows access to Administration programming. This prevents unauthorized or unintentional changes to **settings**. To ensure security, distribute the passwords only to selected **personnel**, keep a record of your password in a secure place, and change the password periodically.

The password is a one to six-digit number. The default Administration password is **A** **D** **M** **I** **N** which is the same as **2** **3** **6** **4** **6**.

Use the **[Show]** button, the **CHANGE** display button and the dial pad to enter the new Administration password. Use the **OK** display button accept the programmed password.

Programming hints

The password is easier to remember if the digits correspond to the letters in a word.

If you forget the Administration password, you are not able to access Administration programming. Call your Customer Service representative to assign a new Administration password.

Log Defaults

If you subscribe to Call Display services, external calls can be tracked in a Call Log. Log Defaults programming customizes how log space is allocated to telephones throughout the system.

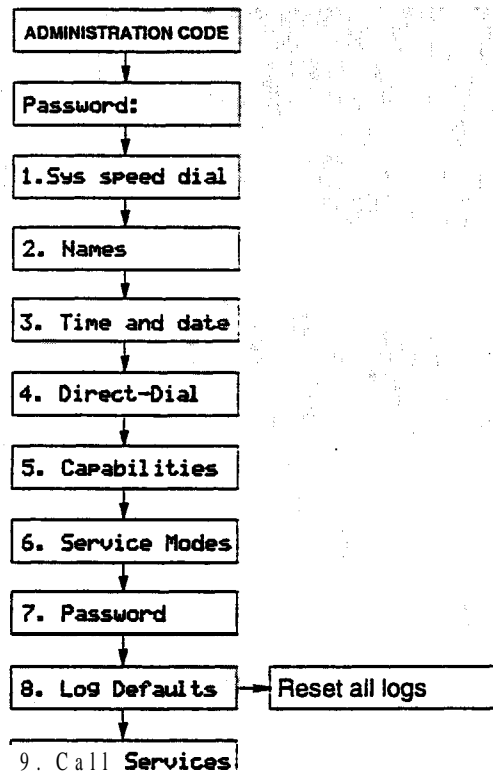

Reset All Logs

Use the **Quit** button and the dial pad to enter the space allocation for the Call Log at each telephone. Use the **OK** display button to accept the settings and end Administration programming. The system automatically reallocates Log space.

Note: Reallocation of Call Log space may destroy Call Log data at telephones that lose space.

There are 160 Call Log spaces available in the system. There are no spaces allocated by default. Changing the space allocation using Log Defaults will define the log space available to every telephone in the system. Unassigned log space is available in a Log Pool and can be re-allocated in Call Services programming.

Call Services

If you subscribe to Call Display services, external calls are identified on the display. Call Services programming allows you to customize how this information is used.

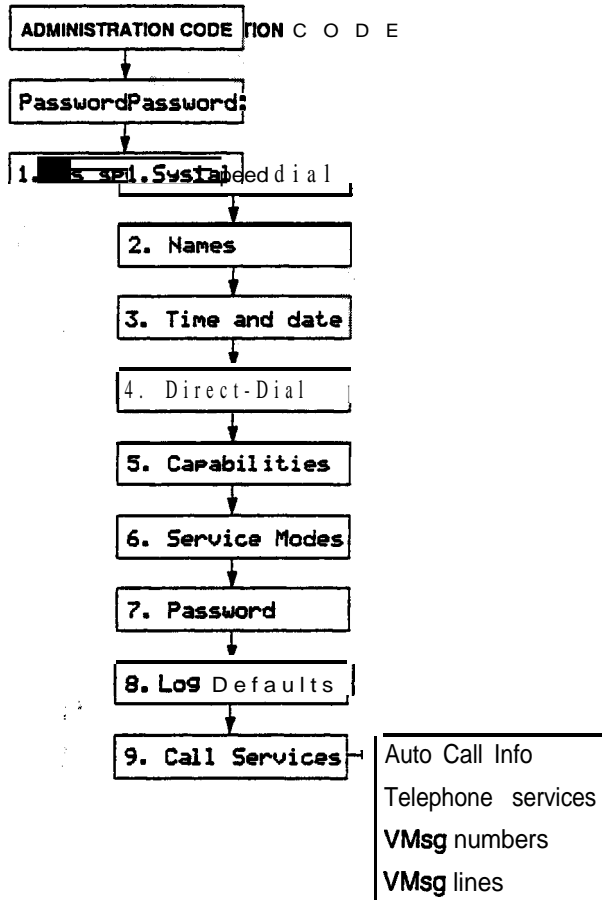

Auto Call Info

Automatic Call Information allows you to specify which telephone displays the Call Display information when a call is ringing on an external line. (After the call is answered, Call Display information is always shown at the telephone that answered the call.) Use the **CHANGE** display button and the dial pad to enter the internal number of the telephone to display Call Display information.

Note: In order for a telephone to display the Call Display information for calls on an external line, that telephone must also be programmed to Ring for that line.

Telephone (Set) Services

Telephone Services programming allows you to customize how Call Display information is used at each telephone.

Autolog/Show Voice Message

Logging telephone (set)

Logging telephone allows you to specify the telephone that , **automatically** logs Call Display information for calls on an external line, The line must appear on that telephone but it does not have to be a ringing line. Use the **CHANGE** display button to select the. setting; N (No) or Y (Yes).

Show External Voice Message

If you subscribe to Voice Message services, you can access that service through your Norstar system. Show External Voice Message controls the display of External Voice Message Waiting indication for each line at each telephone. The telephone must have an appearance of that line. Use the **CHANGE** display button to select the setting: N (No) or Y (Yes).

L o g S p a c e

Log Space changes the number of items that can be stored in the Call Log for each telephone. Use the **[Show].:** button, the **ADD** display button and the **REMOVE** display button to redistribute the log space. There is no log space assigned by default.

Programming hints

Space must be available in the Log Pool before any space can be added to a current Call Log space.

System-wide allocation of space is performed from Log Defaults programming. If you are performing extensive changes, it may be appropriate to use the Log Defaults programming mechanism instead.

Log Password

Log Password **allows** you to clear any Call Log password programmed with the Call Log feature. Use the **CHANGE** display button to clear the programmed password.

First Display

Depending on the services you subscribe to, Call Display information may contain up to three parts; the name of the caller, the number of the caller, and the name of the line in your Norstar system that the call is on. Use the **CHANGE** display button to select the setting to be shown first for each telephone: Name, Number or Line.

Programming hints

The Call Information feature is used to display and scroll through all of the Call Display information; the caller name, number and line number. See the Telephone features chapter for more information.

You may see **Unknown** name or **Unknown** number on the display if the information is not available from your telephone company. You may see **Private name** or **Private** number on the display if the caller blocks that information.

Voice Message Center telephone numbers

If you subscribe to Voice Message services, you can access that service through your Norstar system. This setting specifies the **external telephone** number that is automatically dialed by the Message feature to retrieve voice messages. Use the **CHANGE** display button and the dial pad to enter the external telephone number.

Programming hints

The display does not show that external messages are waiting unless the Show External Voice Message prompt is set to Yes.

Five Voice Message Center numbers can be programmed, but most systems require only one.

Voice Message Center lines

If you subscribe to Voice Message services, you can specify which Voice Message Center is used for each external line that can receive Message Waiting Indication. Use the **CHANGE** display button to select the setting: 1, 2, 3, 4, 5, or N (None).

Copying settings

Programmed settings for lines, telephones, and certain Capabilities can be copied to other lines or telephones. If many lines or telephones require the same settings, program one line or telephone, and then copy those settings.

Line programming

Line programming can be copied for Line abilities in the Capabilities section of Administration programming, and Ringing telephones in the Service Modes section of Administration programming.

Use the COPY display button and the dial pad to identify the source and destination of the copied information.

Telephone programming

Norstar telephone programming can be copied for Set Abilities in the Capabilities section of Administration programming.

Use the COPY display button and the dial pad to identify the source and destination of the copied information.

Capabilities programming

In addition to Line abilities and Set abilities, Norstar Capabilities programming can be copied for:

- Dialing filters
- COS passwords

Use the COPY display button and the dial pad to identify the source and destination of the copied information.

Programming reminders

The Programming reminders are a record of programmable settings which **Norstar** users may need to know on a day-to-day basis.

Fill out whatever sections are programmed and must be known. If more space is required to record the information, first photocopy the page before you begin. Not all of the programmable features may be required information.

Programmable settings can be determined from a review of the *Compact DR5 Programming Record*.

Distribute the Programming reminders to each desk that has a **Norstar** telephone, or post them on the wall next to the telephone.

Norstar telephones

User name/location	Internal number	Page zone
	-----	--
	-----	--
	-----	--
	-----	--
	-----	--
	-----	--
	-----	--
	-----	--
	-----	--
	-----	--
	-----	--
	-----	--
	-----	--
	-----	--
	-----	--
	-----	--
	-----	--
	-----	--
	-----	--
	-----	--
	-----	--
	-----	--
	-----	--
	-----	--

Prime telephone

Prime Telephone operator	
Internal number	_____
Lines answered at the Prime telephone	- - - - -
- - - - -	- - - - -

Page zones

Page zone	Location
1	
2	
3	

Line Pools

Pool	Accesscode	Use
A	- - - -	
6	- - - -	
C	- - - -	

Miscellaneous programming

Direct-dial telephone	_____
Direct-dial digit	---
Call Park Prefix digit	---
Dial first to make external calls	---

Call Pickup Groups

Pickup Group	Names of members of the group
—	<hr/> <hr/> <hr/> <hr/> <hr/> <hr/> <hr/> <hr/>
—	<hr/> <hr/> <hr/> <hr/> <hr/> <hr/> <hr/> <hr/>
—	<hr/> <hr/> <hr/> <hr/> <hr/> <hr/> <hr/> <hr/>

Service Modes

Service Mode 1	Service Mode 2	Service Mode 3
Name -----	Name -----	Name -----
Start Time stop Time -----	Start Time Stop Time -----	Start Time stop Time -----
Control telephone -----	Control telephone -----	Control telephone -----
Ringing telephones ----- ----- ----- ----- ----- ----- ----- ----- ----- ----- ----- ----- ----- ----- ----- -----	Ringing telephones ----- ----- ----- ----- ----- ----- ----- ----- ----- ----- ----- ----- ----- ----- ----- -----	Ringing telephones ----- ----- ----- ----- ----- ----- ----- ----- ----- ----- ----- ----- ----- ----- ----- -----
Extra-dial telephone -----	Extra-dial telephone -----	Extra-dial telephone -----

Telephone features

Answer a **call**

Answering the **telephone** 67

Call Information 80

Call Pickup 68, 94

Handle many calls at once,

Answer buttons 137

Call Queuing 97

Hold, 124, 137

Prime telephone 68, 149

Bring another person into a **telephone** conversation'

Conference 100

Group Listen 121

Handsfree/Mute 68, 122

Privacy 100

Have your calls **answered at** another telephone

Call Forward 77

Service Modes 145

Change your telephone defaults

Button Inquiry 118

Contrast Adjustment 105

Class of Service 104, 154

Customizing your telephone 105

Dialing Modes 106

Do Not Disturb 68, 78, 117

Feature programming I 18

Language Choice 107

Line appearance 154

Line buttons 108, 138

Lines 154

Norstar Telephones 137

Prime line 155

Private lines 155

Ring Type 109

Ring Volume 110

Telephone Admin. Lock 110

Log your incoming calls

Autobumping 84

Call Log 81, 82

Logit 83

Make calls quickly without

having to dial the whole number

Autodial 74

Hotline telephone 148

Last Number Redial 112

Messages 131

Speed Dial 150

Saved Number Redial 113

Make calls to numbers outside your **Norstar** system

Dialing 112

External line access code 112

Host System Signaling 126

Line Pools 129, 155

Check the length of a call

Call Duration Timer 157

Show Time 157

Transfer a call to another person

Call Park 92

Camp On 98

Transfer 98, 158

Communicate within your office

Dialing 112

Direct-dial 112, 147

Page 141

Priority Call 143

Ring Again 112

Voice Call 162





'Using Norstar features

To use a Norstar feature, enter the feature code and watch your telephone display for instructions. Different displays come up at different times, depending on how you invoke the feature and the choices you make while using the feature. If you want more information about a display, look it up in the **Displays** section of each feature listing.

Note that some features work only in certain circumstances. For example, to use Conference you must have two calls at your telephone, one active and one on hold.

One-line and two-line displays

All Norstar telephones have LCD displays that give you information about your calls and guide you through Norstar features. The M7100 and M7208 Telephones have a one-line display. The M7310 and M7324 Telephones have a two-line display. The second line of a two-line display shows the functions of the three buttons directly below it. If you have a telephone with a two-line display, you can use these display buttons. Some display buttons, such as **TRANSFER** and **ALL**, are simply shortcuts. If you have a telephone with a one-line display, these shortcuts are not available. Other display buttons, such as **OK** and **SHOW**, perform essential functions. If your telephone has a one-line display; you can use the following buttons in place of these display buttons:

OK		CANCEL	EI
QUIT		VIEW	EI
ADD	EI	OVERRIDE	#
SHOW	#	BKSP	 

All displays listed in this book are shown as they appear on the two-line display, except those that appear only on telephones with a one-line display. If you are using a telephone with a one-line display, ignore both the second line of the display shown in this book, and the instructions for using display buttons.

Common feature displays

You may see the following displays when you use a feature.

Access denied

Someone is using Configuration of Administration programming. You cannot use programming features. Try again later.

Feature timeout

You have taken more than 15 seconds to press a button in response to a display.

Invalid code

You have entered an invalid feature code.

Not available

You have tried to use a feature that is not available in the present set-up of your Norstar system.

Set locked

You cannot use the feature you have chosen because your telephone is locked. See Telephone Administration Lock in Customizing your telephone.

Dialing and Answering the telephone

Many Norstar features require you to dial telephone numbers. The displays associated with dialing are listed in the Dialing section. If you see a display that is not listed with the feature you are using, look for it in the Dialing section. All the displays that appear when you are receiving a call are listed in the Answering the telephone section.

One button access

You can program most **Norstar** feature codes onto telephone memory buttons so that you can use the feature by pressing a single button. See the procedures in the Feature programming section.

Whenever the instructions tell you to enter a feature code, you can do so either by pressing the buttons shown in the feature description or by pressing a memory button on which the feature code has been programmed. You can also enter a telephone number by pressing an **Autodial** button, rather than entering it manually.

Canceling a feature

Some features change the way your telephone works. To make your telephone work normally again you must cancel the feature. To cancel a feature, press , then I# and the feature code. For example, to cancel Call Forward, which you activate by pressing (4, press # .

If a feature code is programmed onto a memory button, you may be able to cancel the feature by pressing the memory button while the feature is active.

If you change your mind in the middle of using a feature, you can back out by pressing or . Be aware that pressing disconnects any active or held call.

M7100 Telephone

Because the M7100 Telephone does not have any line buttons it sometimes works slightly differently from other **Norstar** telephones. Where other telephones may require you to select a line button to answer a call, on the M7100 Telephone you simply pick up the receiver. Where other telephones require you to select a line button to take a call off hold, you press on the M7100 Telephone. The M7100 Telephone cannot have a button. You will find special instructions for the M7100 Telephone in some feature descriptions.

Answering the telephone

Answering

Your Norstar telephone can receive many different types of calls, Your telephone's display tells you what type of call you are receiving. The usual way to answer a call is to pick up the receiver, but there are several other possible methods, 'depending on how your system is set up and the type of call that is ringing.

Callback

When you direct a call you have answered to another telephone, the system monitors the call to make sure someone answers it. If no one answers a call within a programmable length of time, the system directs it back to you. Callback generates a variety of displays. Most occur after a programmable delay and are listed in this section. Some occur immediately, if the telephone to which you are directing-a call is out of service or otherwise unavailable. These are listed with the descriptions of the features in which they occur.

Delayed Ring Transfer (DRT)

If no one answers a call within a programmable length of time; the system transfers the call to the Prime telephone.

Call Display information

If you have subscribed to Call Display services from your local telephone company, one line of information about an external caller is displayed after you answer. If your telephone has been programmed to receive Call Display information automatically, that information is shown before you answer. Depending on the setting in Administration Programming and the external information available, either the caller's name or telephone number is displayed.

When you transfer an external call to another Norstar user, this information is displayed on the recipient's telephone.

There will be a delay between the time your telephone rings and when Call Display information is available. If you answer a call before the Call Display information arrives, that information is not available for the call.

Related features

Call Pickup

Call Pickup lets you use your telephone to answer a call that is ringing at someone else's telephone.

Call Queuing

Call Queuing allows you to choose the call with the highest priority when you have more than one call ringing at your telephone.

Do Not Disturb

Feature 8 5

If you do not wish to receive calls, turn on, Do Not Disturb.

Handsfree/Mute

Handsfree

You can answer calls without picking up the receiver using Handsfree/Mute.

Prime telephone

A Prime telephone receives calls that go unanswered at other telephones. For more information, see Special telephones.

Retrieving a Parked Call

You can retrieve a parked call at any telephone in the system.

Voice Call Deny

Feature 8 8

If you do not wish to receive voice calls, turn on Voice Call Deny.

What line indicators mean

- | | |
|---|---|
| ▶ Flashing on and off for equal lengths of time | There is an incoming call on the line. |
| ◻ 50% Flashing on and off more quickly | You have placed a call on hold. |
| ▶ Flashing on for longer than off | Someone else has put a call on hold on that line. |
| ▶ On, not flashing | You are connected to the call on that line or the line is in use elsewhere. |
| Off | The line is free. |

Rings you may hear

- | | |
|---------------------------------|--|
| A double beep every ten seconds | A call has been camped to your telephone. |
| A long single ring | There is an external call on the line for you. |
| A shorter double ring | There is an internal call on the line for you or a call is being transferred to you. |
| Three beeps descending in tone | You are receiving a priority call. |

Displays

You will see one or more of the following displays when you receive a call on your telephone and while you are answering that call. See Messages for a full explanation of the Messages feature. See Dialing for a full explanation of Ring Again.



This indicates a long distance call.

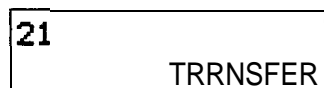

You are connected to an internal call. You can press TRRNSFER to transfer the call.

02>21

Either you are receiving an internal call from telephone 02 forwarded by telephone 21 or you have an Answer button for telephone 21 and an internal call from 02 is ringing on 21.

21 calling

You are receiving a call from telephone 21.

Call 21?
YES NO

You have received a Ring Again offer for a call to an internal telephone. To call the number again, press **YES** or the flashing internal line button. On the **M7100** Telephone, just lift the receiver. Otherwise, press **NO** or wait 30 seconds for the Ring Again offer to expire. For an explanation of Ring Again, see Dialing.

Camped: 21
CALLBACK

The person to whom you camped the call did not answer it. The call has come back to you. Press the **CALLBACK** button or the line button to reconnect to the call.

Line 01
TRANSFER

You are connected to an external call. You can press **TRANSFER** to transfer the call.

/Line 01 transfer

The call on line 01 is being transferred to you by someone else in your **Norstar** system.

Line 01>21

Either you are receiving an external call forwarded from telephone 21 or you have an Answer button for telephone 21 and an external call is ringing on that telephone.

No calls waiting

You tried to use Call Queuing but no call was ringing at your telephone.

No line selected

There is no call ringing at your telephone. If you have a flashing line button but your telephone is not ringing, you must press the line button to answer the call on that line,

Not in service

The telephone to which you have directed a call is not in service or is otherwise unavailable. The call is returned to your telephone.

**Parked call
CALLBACK**

Nobody answered the call you parked. The call has come back to you,

Pick up receiver

You have used the Call Queuing feature without picking up the receiver and Auto Handsfree has not been assigned to your telephone. You must use the receiver or **Handsfree** to answer a ringing call.

**Priority >21
BLOCK**

You are receiving a Priority Call. If you are on another call, inform the person you are speaking to that the call is about to be put on hold. Press the flashing line indicator of the Priority Call or wait till the call connects automatically (in eight seconds). The Priority Call goes through when you hear the next beep. Your active call is placed on Exclusive Hold. It will be reconnected automatically when the priority call ends (unless you transfer the Priority Call, in which case you must press the line button of your original call to r e c o n n e c t) . To reject a Priority Call, use DND (**Feature L 8 9**) or Press **K**.

Release a call

You have no free line buttons on which to receive a call. Release one of your current calls and try again to answer the incoming call.

Use line Pool?
YES NO

You have received a Ring Again offer for a line pool. To use the line pool, press **YES** or the flashing internal line button. On the M7100 Telephone, just lift the receiver. Otherwise, press **NO** or wait 30 seconds for the Ring Again offer to expire. For an explanation of Ring Again, see Dialing.

Prime telephone displays

If yours is a Prime telephone, you may see the following displays:

DND from 21

The person at telephone 21 has forwarded an external call to you using Do Not Disturb.

DND transfer

The system has transferred an external call to you from a telephone in Do Not Disturb mode.

DRT Line 81

Nobody answered this call on line 01, so the system transferred it to you.

Line 01 callback
CALLBACK

Someone has camped, parked or transferred a call on line 01, but no one has answered it. Press the **CALLBACK** button or the line button to connect to the call.

/Line 01 to prime

There is no telephone that can receive a call on line 01 so the System has transferred it to you.

Line 03>Line 07

The call coming in on line 03 was intended for line 07. Line 07 is busy so the call has come to you.

Notes

There are three indications of an incoming call: ringing, a line button flashing, and a message on the display. You will not necessarily receive all three indications for any particular call. You may have a line that has been set up not to ring at your telephone. If so, you will see only a flashing line button. If someone makes a voice call to you, you will hear a beep followed by their voice. There are many possible combinations, depending on how your system is set up. See Lines in the System features section for more information on the use of lines.

There are many ways to answer a call. Many of them depend on settings in Administration programming. Depending on various settings and the type of call you are receiving, you may be able to answer a call by: picking up the receiver, picking up the receiver and pressing a line button, pressing **Handsfree**, pressing **Handsfree** and pressing a line button, pressing a line button, or simply speaking.

If you receive a Priority Call and your telephone has no free internal line buttons, you cannot transfer the call or do anything else with it, except release it.

On M7100 Telephones, you may answer a second call by pressing **[Hold]**. Your active call is put on hold and you are connected to the waiting call. You can have no more than two calls at a time.

Autodial

You can program memory buttons for one-touch dialing of internal or external telephone numbers.

External Autodial

Feature * 1

1. Press Feature * 1 .
2. Select the button you want to program. This is not necessary for the M7100 Telephone.
3. If you want this autodialer to use a particular line or line pool, select that line or line pool button. You can only select a line pool button on the M7100 Telephone.
4. Enter the number.
5. Press **OK** or Hold .

Internal Autodial

1. Press Feature * 2 .
2. Select the button you want to program. This is not necessary for the M7100 Telephone.
3. Enter the number.

Displays

You will see some of the following displays while programming an Autodial button. See Dialing for displays that may occur while using an Autodial button.

987_
QUIT BKSP OK

Continue to enter digits until the number is complete. Press **BKSP** or ⇒ to erase an incorrect digit. Press **OK** or Hold when you are finished.

Autodial full

The memory allotted to Autodial numbers in your Norstar system is full.

Button erased

While programming External Autodial, you pressed **OK** or **(Hold)** before entering any digits. This erases the button.

Enter digits
QUIT OK

Enter the number you wish to program exactly as you **would** if you were **dialing it** yourself.

Hold or release

You cannot program an **Autodial** button **while** you are on a call. Finish your call or place it on hold before programming an **Autodial** button

Intercom #: _
QUIT

Enter the internal telephone number you wish to program.'

Press a button
QUIT

Press the memory button you want to program.

Program and HOLD

This display pertains only to the M7208 Telephone. Enter the number you want to program onto the button, then press **Hold**. You may include a line or line pool selection in an **autodial** sequence by selecting the line before entering any digits.

Program and OK
QUIT OK

Enter the number you want to program onto the button, then press **(Hold)** or **OK**. You **may** include a line or line pool selection in an **autodial** sequence by selecting the line before entering any digits.

Programmed

The number is stored on the button.

Notes

If the power to your **Norstar** system is off for more than three days, **Autodial** numbers may be lost from the memory.

Autodial numbers must be programmed onto memory buttons. They can not be programmed onto line buttons, the Handsfree/Mute button, or Answer buttons.

You can program Host System Signaling codes as part of a number on an External **Autodial** button. See Host System Signaling.

If you do not include a line selection in an autodialer, the call will use your Prime line, if you have one. If you select a line before pressing the **Autodial** button, any line selection programmed onto the button will be ignored.

You can copy the telephone number from a Last Number Redial button or Saved Number Redial button onto an **Autodial** button. Simply enter the Last Number Redial feature code or Saved Number Redial feature code when the **Autodial** feature asks you to enter a number,

Call Forward

Feature 4

Forward your calls

You can have all your calls forwarded to another telephone in the Norstarsystem.

1. Press Feature 4 .
2. Enter the number of the internal telephone to which you want your calls forwarded.

Forwarding remains in effect until you enter the Cancel Call Forward feature code.

Cancel Call Forward

Feature # 4

You can start to receive calls again.

1. Press Feature # 4 .

Call Forward on Busy

Call Forward on Busy redirects calls to another telephone when you are busy with a call. The System Coordinator sets up Call Forward on Busy in Administration programming.

Call Forward (No Answer)

Call Forward (No Answer) forwards unanswered calls to another telephone. The System Coordinator sets up Call Forward (No Answer) in Administration programming.

Call Forward Override

You can call someone and ask them to stop forwarding their calls to you.

1. Dial that person's number and ask them to cancel call forwarding. Your call will ring at that person's telephone even though they are forwarding their calls.

Related features

Do Not Disturb

Feature 8 5

You can use the Do Not Disturb feature to forward your calls to the Prime telephone.

Displays

You will see some of the following displays while forwarding your calls. See Do Not Disturb for a full explanation of that feature. See Answering the telephone for displays that occur when a telephone receives a call forwarded by another telephone.

Forward denied

You cannot forward calls to the number you have chosen. There are several reasons why this can happen. For instance, you cannot forward your calls to a telephone that has been forwarded to your telephone.

Forward to:

Dial the internal number or press the Internal **Autodial** button of the telephone to which you want your calls to be forwarded.

Forward>21
CANCEL

Your calls are being forwarded to telephone 21. Press the **CANCEL** button or **Feature** **#** **14** y o u want to stop forwarding your calls.

/Not in service

Two or more telephones are linked in a forwarding chain, and one of them is out of service or is being used to program the system.

Notes

When a call is forwarded, it does not ring but its line indicator still flashes on your telephone. You can answer the call by pressing the button next to the flashing indicator.

If the telephone to which you forwarded your calls does not have the same external lines as your telephone, the forwarded calls appear on internal line buttons.

Telephones that have Call Forward on Busy active can still receive Priority calls.

Call Forward on Busy does not forward camped calls.

You cannot forward your prime line if it is in a line pool.

When Call Forward is active, all calls go to the Call Forward destination, regardless of the Call Forward on Busy and Call Forward no Answer settings.

If you are one of a group of people who regularly forward their calls to one another, be aware that it is possible to set up forward loops in which a call is forwarded from one telephone to another in a circle, and is never answered anywhere.

Call Information

Feature 8 1 1

Call Information allows you to display information about incoming calls. This information is more detailed than the Call Display information you automatically receive. See the Answering the telephone section in this chapter for details. For external calls, you can display the caller's name, telephone number, and the line name. For an internal call, you can display the name of the caller and their internal number. You can obtain information about ringing, answered, or held calls. Names and numbers for external callers are displayed only if you have subscribed to Call Display Services from your local telephone company.

Names and number&for external callers are displayed only if you have subscribed to Call Display services from your local telephone company.

Display Call Information before or after answering

1. To find out who is calling or to obtain information about your current call, press **Feature 8 1 1**.
2. If the call is an internal call, the caller's name and the internal number are displayed.
OR
If the call is an external call, incoming call information may be available.

To obtain more information about an external call:

For a one-line display, press **#** repeatedly to display more information about the call.

OR

For a two-line display, continue to press **VIEW** to display more information about the call.

Display Call, Information for a **call** on hold

1. To obtain information about your held call, press

.

2. The display shows **Select a call**.

3. **Select** the line on hold,

4. If the call is an internal call, the **caller's name** and internal number are displayed,

OR

If the call is an external call, the **caller's name** is displayed.

To obtain more information about an external call:

For a one-line display, press repeatedly to display more information about the call.

OR

For a two-line display, continue to 'press VIEW to display more information about the call.

Related features

Call Log

Call Log displays the same information as Call Information, along with the date and time of the call, as well as the number of times the caller called.

Displays

```
▶5551234
EXIT VIEW
```

You would see this display if you were on an active call with a caller at 555- 1234.

```
▶55551234
EXIT VIEW
```

You would see this display if you were on an active long distance call with a caller at 555-1 234.

Notes

Call Display information becomes available between the first and second ring of an alerting call. If you answer before the Call Display information is available on your display, and you press

, you will only see the line number or line name.

Call Log

Call Log creates a list of records of incoming external calls. The log could contain the following information for each call:

- sequence number in the Call Log,
- name and number of caller,
- indication if call was long distance,
- indication if call was answered (and identification of who answered it),
- time and date of the call,
- number of repeated calls from the same source, and
- name of the line that the call came in on.

Call Log has many benefits. For example, you may find it helpful to :

- keep track of abandoned or unanswered calls,
- call back a customer who was unable to reach anyone,
- track patterns for your callers (for example volume of calls and geographical location of calls),
- record caller information quickly and accurately, and
- build a personal telephone directory from log items.

Choose Logging, Options

Feature * 8 4

You can select the type of calls that will be stored in your Call Log.

1. Press * 8 4 .
2. If the default has not changed, the display shows **Ho one answered**. If you want to log calls, that were not answered, press **OK** or **O R**
Press **NEXT** or # 'to display the next selection.
3. The display shows **Unanswered by me**. If you want to log calls that were unanswered at your telephone but answered elsewhere in the system, press **OK** or **OR**
Press **NEXT** or # 'to display the next selection.
4. The display shows **Los al 1 calls**. If you want to log all calls, answered and not answered at the telephone, press **OK** or **OR**
Press **NEXT** or # to display the next selection.
5. The display shows **No autologging**. If you do not want information to be automatically logged, press **OK** or **(Feature)**.
OR
Press **NEXT** or # to return to the first selection.
6. To exit, press **Fls** .

Use **Logit** (manually log a call)

Feature 8 1 3

If your calls are not automatically logged, **Logit** lets you manually log call information when you are connected to an external call. Being able to store information for your current call can be helpful in many situations. For example, you may want to:

- record a caller's information without using paper and pencil,
- record only selected calls that you personally choose, as opposed to using Call Log automatically, and
- quickly record caller information before a caller hangs up.

To manually log an external call:

1. Press **Feature** **8** **1** **3**.

OR

Program this feature on a memory key. (See the Norstar Telephones section in this chapter.)

Use Autobumping

Feature **8** **1** **5**

Since your log has a set number of entries that it can hold, Autobumping is a feature that lets you tell Norstar what to do when your log becomes full. When Autobumping is ON, a new log entry causes the first entry to be deleted. If Autobumping is OFF, your Norstar system will not log new calls when your log is full.

1. To turn Autobumping ON, press **Feature** **8** **1** **5**.

OR

To turn Autobumping OFF, press **Feature** **#** **8** **1** **5**.

Enter Call Log

Feature **8** **1** **2**

You can enter your Call Log to view stored information. The Log may display special characters. These are described in detail in the description of Displays, later in this section. To view your log:

1. Press **Feature** **8** **1** **2**.
2. The display shows the number of previously read items (Old) and the number of new, unread items (New) in the log.
3. To view old items, press **OLD** or *****.

OR





To view new items, press **NEW** or **#**.

OR

To return to an item viewed when you last exited the log, press **RESUME** or **0**.

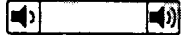
Navigate within Call Log

You can navigate within your Call Log to view a particular log entry. You can also scroll within an entry itself.



1. To scroll through an entry, press **MORE** or  ←
OR
To view the next entry, press **NEXT** or  #.
OR
To go back to the previous entry, press  *.
2. To exit, press  Rls.

Erase Log Items

It is necessary to routinely erase read log items to make space for new items in your log.

1. Navigate to the item you want to erase.
2. Press **ERASE** or **[Hold]**.
3. To exit, press  Rls.

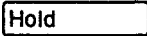
If you accidentally erase an item, you can undo the erasure.

1. Immediately after accidentally erasing an item, press **UNDO** or  Hold.
2. To exit, press  Rls.

Call from Call Log

You may find it helpful to place calls from within your Call Log. Each stored caller number may vary according to the information associated with that particular call. If the caller number involves a **Centrex** or PBX system, the first few digits may need to be “trimmed” to make the caller number dialable. If the number that you want to call is long distance or uses line pool access, digits may need to be added to the beginning of the number.

Place a call

1. Navigate to the log item for the number that you want to dial,
2. Display the number and edit it if necessary to make it **dialable** (the instructions for adding or trimming digits follow).
3. Press an external line or line pool button:
4. Lift the receiver. This is not necessary if Handsfree is programmed at your telephone.
5. The displayed number is dialed.

Trim a number involving **Centrex** or PBX

To trim the caller number:

1. Press **TRIM** or ⇒ , once for every digit that you want to remove.

Add digits for long distance or line pool access

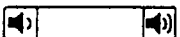
1. Add digits to the number by pressing the appropriate dial pad digits, just as you would do to dial.
2. To remove digits you have added, press **BKSP** or ⇒ , once for every digit that you want to remove.

Optional Password

You have the option of accessing your Call Log through a password. If you forget your password, there is a facility in Administration programming to clear it (and then you could enter a new password from your telephone).

Assign a password to your Call Log

1. Press **Feature** ***** **8** **5**. The display shows
N e w P a s s w r d : _ _
2. Enter your four-digit password. The display shows
Repeat New: , ,
3. Re-enter your four-digit password. The display shows
P a s s w o r d c h a n g e d , which confirms that your password has been assigned.

Using' your Password to enter Call Log

1. Press **Feature** **8** **1** **2** to enter Call Log.
2. If you have programmed a password, P a s s w o r d : _ _ appears.
3. Enter your four-digit password.

Change your password

1. Press **Feature** ***** **8** **5**. The display shows
O l d P a s s w r d : _ _
2. Enter your old password. The display shows
N e w P a s s w r d : _ _
3. Enter your new four-digit password. The display shows
Repeat, New: , ,
4. Re-enter your password. The display shows
P a s s w o r d c h a n g e d , which confirms that your password has been changed.

Delete an assigned password

After assigning a password to your Call Log, you may later decide that you do not want to use a password at all.

1. Press **[Feature] * 8** (5). The display shows
01 d **Passwrd: _.**
2. Enter your old password. The display shows
New Passwrd: _.
3. Press **OK** or **[Hold]**. The display shows
No Pswd assigned, which confirms that your password has been deleted.

Related features

Call Information

The same Call Display information as in Call Log is displayed, but it is not recorded in a log.

Displays

You will see some of the following displays as you use Call Log.

12:KATE SMITH
NEXT ERASE MORE

This is a Call Log item with its sequence number. When the first digit is underlined, it is a new item.

12)KATE SMITH
NEXT ERASE MORE

This indicates that the call was answered.

12SKATE SMITH
NEXT ERASE MORE

This indicates a long distance call.

49/1234567890123
NEXT ERASE MORE

The "slash" symbol (/) indicates that the displayed information for a call has been truncated. Press **MORE** to display the remaining digits

Jan 4 9:00a 3X
NEXT ERASE MORE

This is the repeat call counter, shown along with time and date display. It indicates the number of calls you have received from the same caller.

Autobump ON

The Autobumping feature is active.

Autobump OFF
d e a c t i v a t e d .

The Autobumping feature is deactivated.

Call(s) bumped

One or more calls have been autobumped.

Call for you

There is one new item in the Call Log,

Calls for you
t h e C a l l

Log, There are two or more new items in

Call logged

The call was successfully logged with Logit.

Hold or release

Your active call must be held or released before entering Call Log.

In use: SETNAME

The external line is in use.

Item erased

The item was erased from the Call Log.

LINE 01 21
NEXT ERASE MORE

This display shows that this call was answered at telephone 21.

LINE 01 Logit
NEXT ERASE MORE

This display shows that this call was manually logged.

LINE 01
NEXT ERASE MORE

This display shows that this call was e r e d .

Log is empty

Your Call Log is empty.

Log is full

No additional calls can be logged until you either turn Autobumping ON, or you delete some items in your log.

Messages & Calls
MSG CALLS

This indicates that there are one or more items in your Message Waiting List, and that there are one or more new entries in your Call Log.

New calls begin

This appears before the first "New" item when navigating from the "Old" items to the "New".

No free lines

All lines in the pool are in use.

No info to log

No information is available on the call.

No log assigned

No log space has been assigned to the telephone.

No new items

There are no new calls in the Call Log.

No old items

There are no old or "viewed" items in the Call Log.

No resume item

The resume item is no longer in the Call Log due to Autobumping, repeat call update, or log reallocation.

Private name

The caller's name is private.

Private number

The caller's number is private.

Release calls

On an M7100 Telephone, the active call must be released before entering Call Log.

1:Unknown call

The caller's name and number are unknown.

1:Unknown name

The caller's name is unavailable.

number own

The caller's number is unavailable.

Notes

You may want to use the punch-out overlay, which is provided in the Call Log Feature Card. This card is available in a separately orderable Call Display Key Cap Kit. Please contact your Customer Service representative.

The default log size is zero items. This size can be changed in Administration programming.

The long distance indicator may not be shown in the log, depending on the Call Display services provided by your local telephone company.

For tips on programming Call Logs, see the Call Display services section.

Call Park

 Feature

Park a call

You can suspend a call so that it can be retrieved from any telephone in your system.

1. Press .
2. Use the Page feature to announce the retrieval code displayed by your telephone.

Retrieving a parked call

1. Select an internal line.

OR

If you have an M7100 Telephone, pick up the receiver.

2. Dial the call park retrieval code.

Displays

You will see some of these displays while parking a call. You may see some of these displays while retrieving a parked call.

All ready parked

The person you were talking to has already parked your call. You cannot park the same call.

Get call f first

You have attempted to park a call with no active call on your telephone. If the call you wish to park is on hold, you must reconnect to it before you can park it.

Inval id number

You have entered an invalid retrieval code.

No call on: 101

There was no call on the retrieval code you entered.

No call to park

You have attempted to park a call, but there are no calls at your telephone.

Park denied

conference.

Record the code shown.

PAGE EXIT

Parking full

You have tried to park a conference call. Split the conference and park the calls separately. The person who retrieves the calls can reconnect the

Use Page (Feature 6 0) or press **PAGE** to announce the call and its retrieval code.

All available retrieval codes are in use. Transfer the call or take a message instead.

Notes

When you park a call, the system assigns one of two codes for the retrieval of the call. These codes consist of the Call Park prefix, which may be any digit from 0 to 9, and a two digit call number 01 or 02. For example, if the Call Park prefix is 4, the first parked call is assigned Retrieve Park code 401.

Your Customer Service Representative sets the Call Park prefix in Configuration programming. If the Call Park Prefix is set to None, parking is disabled.

Your Customer Service Representative also sets the Call Park Callback delay in Configuration programming. External calls parked for longer than the program delay are returned to your telephone.

Call Pickup

You can pick up a call that is ringing at another telephone.

Directed Pickup

Feature 7 6

You can answer any telephone that is ringing in your Norstar system

1. Press Feature 7 6.
2. Enter the internal number of the ringing telephone.

Group Pickup

Feature 7 5

Your Norstar system can be divided into as many as four Pickup groups. If you are a member of a pickup group, you can pick up a call that is ringing at any telephone in your pickup group.

1. Press (Feature) 7 5.

Trunk Answer

(Feature) 8 0 0

The Trunk Answer feature allows you to answer an external call that is ringing at any other telephone in your office.

Trunk Answer works only with calls that are ringing on lines for which a Service Mode is active and if Trunk Answer is ON in Administration programming.

1. Press Feature 8 0 0.

Displays

You may see some of these displays while using a Call Pickup feature.

Already joined

You are already connected to the telephone that made the call you are trying to pick up. This can happen if you are on a call to a co-worker, your co-worker dials the number of a telephone in your Pickup group, and you attempt to pick up that call.

**Denied in admin
Pickup**

Your telephone is not a member of a group.

No button free

You have tried to pick up a call when you have no line button available.

Pickup denied

(Pickup) There is **no call** that you can pick up or the call that was ringing has already been answered

(Trunk Answer) The call that is ringing is on a line that is not in a Service Mode.

You have attempted to pick up a call on someone else's private line.

Pickup:

Enter the internal number of the telephone that is ringing. (You may use an Internal **Autodial** button to do this.)

If you decide not to answer a ringing call once you have activated Directed Pickup, press [Feature]. The call will continue to ring.

Notes

Call Pickup cannot be used on private lines.

To use Directed Pickup, the telephone must be ringing. If, for example, the auxiliary ringer is ringing, but the call is not ringing at a telephone, the call cannot be answered using Directed Pickup. It must be answered normally at a telephone that has a flashing indicator for the call, or by using Trunk Answer.

If a call is ringing on an Answer button, you can use Directed Pickup to answer the call by entering the internal number of any member of the Answer group.

If there is more than one incoming call at a telephone in a pickup group, a call ringing on the Prime line is answered first followed by calls on external lines and, finally, calls on internal lines.

If there is more than one incoming call on lines in a Service Mode, the Trunk Answer feature picks up the external call that has been ringing the longest.

The System Coordinator can assign telephones to one of four Pickup groups in **Administration** programming.

Call Queuing

Feature 8 0 1

When you have more than one call ringing at your telephone, you can choose the call that has the highest priority.

1. Press Feature 8 0 1.
2. The system connects you to the call that has the highest priority.

Notes

Call Queuing answers incoming calls before callback calls.

Call Queuing can be programmed onto a memory button.

Camp On

 Feature

Camp a **call**

You can send an external call to another telephone, even if all its lines are busy.

1. Press .
2. Dial the number of the telephone you want to camp the call to.

Related features

Transfer

 Feature

Camp On is a variation of the Transfer feature.

Displays

You will see some of the following prompts while Camping a call.

**21 Camp max
CALLBACK**

You tried to camp a call to a telephone that already has a camped call. The call has come back to you. Press the **CALLBACK** button or the line button to reconnect to the call. On the M7100 Telephone, just pick up the receiver.

**21 DND
CALLBACK**

The person to whom you redirected a call has Do Not Disturb active on the telephone. The call has come back to you. Press the **CALLBACK** button or the line button to reconnect to the call. On the M7100 Telephone, just pick up the receiver.

Camp denied

You have tried to camp an internal call. You can only camp external calls.

**Camp to:
CANCEL**

Dial the number of the internal telephone to which the call will be sent.

**Camped: 21
CALLBACK**

The telephone to which you camped a call did not answer the call. The call has come back to you. Press **CALLBACK** or the line button to reconnect to the call. On the M7100 Telephone, just pick up the receiver.

Line 01 hung up

A call you camped has come back to you, but the caller hung up before you could reconnect.

Make call first

You have no call to camp. If the call you want to camp is on hold, take it off hold and then camp it.

**Not in service
CALLBACK**

The telephone to which you have camped a call is out of service or is being used for Configuration or Administration programming. The call has come back to you. Press **CALLBACK** or the line button to reconnect to the call. On the M7100 Telephone, just pick up the receiver.

Release a call

The line that the camped call is on is in use or that line does not appear at your telephone. Release the line or release an internal line.

Notes

If you use Call Queuing to answer a camped call, external calls are answered before the camped call.

Camped calls appear on a line button on the receiving telephone, if one is available. If not, there is just a message on the display and Camp tones.

Conference

Feature 3

Create a conference

You can talk to two people at once.

1. Make sure you have two calls, one active and one on hold.
2. Press Feature 3.
3. Take the held call off hold (this is automatic on the M7100 Telephone).

Conference using Privacy

Feature 8 3

Normally your calls are private; no one else can pick up your line and join in your conversation. You can turn privacy off for a call allowing another person with the same line to press the line button and join in your conversation, forming a conference.

1. Press Feature 8 3.
2. Tell the other person to press the line button and join your conversation.

Disconnect one party

You can disconnect one party from a conference and continue talking to the other.

1. **Press** the line button of the call that you want to disconnect. The call that you want to keep is automatically put on hold.
OR
For the M7100 Telephone, press Feature # 3, which places one party on hold. Press [Hold] again if necessary, to put on hold the party that you want to keep.
2. Press Ris. The call is disconnected.
3. To speak to the remaining party, press the line button of the held call, or for the M7100 Telephone, press [Hold].

Independently hold **two calls**

For all Norstar telephones except the M710 Telephone, you can put the two people on hold independently so that they cannot talk to each other.

1. Press the line button of one person,, The other person is automatically put on hold.
2. Press [Hold]. The second person is put on hold.

You can reestablish the conference.

1. Take one call off hold.
2. Press .
3. Take the other call off hold.

Put a conference on hold

You can put a conference on hold, allowing the other two people to continue speaking to each other,

1. Press . The display shows **Conf on hold**.

You can reconnect to the conference.

1. Press either of the held line buttons, or for the M7100 Telephone, press [Hold]. You are reconnected.

Split a conference

You can talk with one person while the other person is on hold.

1. Press the line button of the person you want to speak to. The other person is automatically put on hold.

O R

For the M7100 Telephone, press , which puts the first party on hold. Press again if necessary to switch parties.

You can reestablish the conference,

1. Press .
2. Take the held call off hold. This is not necessary for the M7100 Telephone.

Displays

You will see some of these displays while using the Conference feature.

3 parties only

You are trying to add a fourth party to your conference call, or to join two conferences together. Release one call from the conference before adding another, or keep the two conferences separate.

Access denied

Privacy control cannot be used on internal or conference calls.

Conf. on hold

You have put a conference call on hold.

Conference busy

You have tried to make a conference call, but your system is already handling its maximum number of conference calls.

**Line 81 21
TRANSFER**

You are on a conference with the two lines or telephones shown.

Make calls first

You have tried to set up a conference call, without having made the calls that are to be connected. Make both calls first.

Make call first

You have tried to use Privacy Control when you are not on a call.

/Make second call

You have tried to set up a conference call while connected to only one caller. Put your first call on hold, make a second call, and enter the Conference feature code again.

No button FREE

You have put a conference call on hold from your M7100 Telephone, then tried to get another line. Your M7100 Telephone can handle only two lines at a time, and your conference call is using both of them.

Press held line

You have, activated the Conference "feature with one call active and another on hold. Press the line of the call on hold to bring that person into the conference.

Notes

Only the person who established the conference can process the conference in any of the ways just described,

The Conference feature supports only three people.

If you are using an M7100 Telephone:

- Your conference is connected as soon as you enter the Conference feature code. There is no need to take the second call off hold.
- To split a conference, press **Feature** **#** **3**. Then, press **[Hold]** to change from one caller to the other.
- You cannot independently hold two calls.
- You cannot join an existing two-party call to establish a Privacy conference although you can use the Privacy feature for calls at your telephone.

When a third person joins a conversation on a line that has privacy turned OFF, the call becomes a conference. All the rules applicable to a conference apply except that there is only one-line in use, instead of the normal two. This means that you cannot split a conference that was set up using Privacy.

In certain situations, you may experience lower volume levels when using the Conference feature with two external calls.

COS Password

Feature 6 8

Change **your** Class of Service

A Class of Service password is a six digit code that lets you switch from your current Class of Service to one that lets you dial numbers prohibited by your current Class of Service.

1. Press **Feature** **6** **8**.
2. Enter your COS password.

Displays

You will see the first of these displays when entering a COS password, you may also see the second.

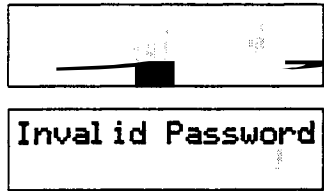

(Blank display) Enter your password. will not be shown on the display.

You have entered a password that is not programmed into your system.

Notes

You must enter a Class of Service password each time you wish to make a call using a Class of Service not normally available on your line or telephone.

Norstar allows up to 19 Class of Service Passwords.

The System Coordinator defines Class of Service passwords in Administration programming.

Customizing your telephone

You can change the way a telephone works in several ways. Some of the following features are assigned to telephones in Administration programming. You can turn other features ON and OFF at individual telephones.

Automatic Handsfree

Automatic Handsfree lets you make or answer a call without having to pick up the receiver or press the **Handsfree** button. The telephone's internal microphone and speaker turn on automatically when you make or answer a call.

The System Coordinator assigns Automatic Handsfree capability to a telephone in Administration programming. Full Handsfree capability must be assigned to a telephone before Automatic Handsfree capability can be assigned to it. This is also done in Administration programming.

This feature is not available on M7100 Telephones.

Contrast Adjustment

Feature * 7

You can set the contrast level of your telephone display.

1. Press **Feature** * 7.
2. Choose the contrast level you like best. The number of contrast levels available varies from one Norstar telephone to another.

This is the display you will see in Contrast adjustment.

```

Contrast level 21
DOWN  UP  OK
  
```

Press a number for the contrast level you want or press **UP** or **DOWN**. Press **Hold** or **OK** to set the new contrast level.

Dialing Modes

Feature * 8 2

You can set the dialing mode of your telephone.

1. Press Feature * 8 2.
2. Choose the dialing mode you want.

Norstar supports three dialing modes; Automatic Dial, Pre-Dial, and Standard Dial. All three modes support on-hook dialing. (On-hook dialing means dialing a call without picking up the receiver.) The special features of the Automatic and Pre-Dial modes are available only when you dial on-hook.

The Dialing Modes feature code cannot be programmed onto a memory button.

Standard Dial

In Standard Dial mode, you make a call by selecting a line and dialing the number. If you have a Prime line, it is selected automatically when you lift the receiver or press Handsfree.

Standard Dial does not support on-hook dialing on an M7100 Telephone. If you have an M7100 Telephone, use the Automatic Dial or Pre-Dial feature for on-hook dialing.

Automatic Dial

If you have a Prime line assigned to your telephone, Automatic Dial allows you to dial a number without selecting a line. Your Prime line is selected as soon as you start dialing a number. Automatic Dial does not work if your Prime line is in use.

Telephones connected to an Analog Terminal Adapter (ATA) cannot use Automatic Dialing.

Pre-Dial

Pre-Dial allows you to enter a telephone number, check it, then change it before actually making the call. The call is not dialed until you select a line or line pool, or pick up the receiver.

You can pm-dial both external and internal numbers. You must, however, select the correct type of line (external or internal) for the type of number you have entered.

If all the lines on your telephone are busy, you will not be able to enter a telephone number.

If your telephone starts ringing while you are pre-dialing a number, you can stop the ringing by turning on Do Not Disturb (Feature). This does not affect numbers you are entering.

This is the display you will see when selecting a Dial mode.



The current dial mode is shown. Press or NEXT until the dial mode you want appears. Press or OK to select the displayed dial mode. If Automatic Dial is not available it is because you have no Prime line.

Language Choice

English * 5 0 1
 You can select English as the language of your telephone display.

1. Press * 5 0 1 .

Alternate Language * 5 0 2
 You can select the alternate language as the language of your telephone display.

1. Press * 5 0 2 .

Each Norstar system supports English and one alternate language. Norstar systems are available with either French or Spanish as the alternate language. Button caps are available in both alternate languages.

You can select either English or the alternate language at each telephone. When your system is first installed, all telephones will use English.

You can program a memory button for one-touch switching between languages. Program **[Feature] * 5 0 1** onto the button. Pressing the button will switch you back and forth between English and the alternate language.

[Feature] * 5 0 2 cannot be programmed onto a memory button.

One of the following displays will appear when you enter a language choice feature code.

En français...

Telephone display messages will be in French.

En español...

Telephone display messages will be in Spanish.

In English...

Telephone display messages will be in English.

Move Line buttons

[Feature] * 8 1

You can move external lines to different buttons on your telephone. You can use this feature to arrange your lines in the way that makes the most sense to you.

1. Press **[Feature] * 8 1**.
2. Press the button you want to move the line from.
3. Press the button you want to move the line to.

You will see some of these displays while moving lines.

Invalid location

You have tried to move a line to a button that cannot be used as a line button, such as a **Handsfree/Mute** button, or an **Answer** button.

Move line from:
QUIT

Press the button of the line you want to move. Press **QUIT** or **Feature** when you have finished moving lines.

Move line to:
QUIT

Press the button you want to move the line to. Neither of the buttons is erased. The lines, or the line and feature, simply switch places,

Press a line

The button you are trying to move is not a line button. If you are trying to switch a line and a feature, move the line to the feature button and not vice versa.

Pulse/Tone Dialing

Each external line is set to either pulse or tone dialing. Pulse dialing is the traditional method of dialing used by rotary dial or push button single-line telephones. Tone dialing allows telephones to communicate with other devices such as answering machines. Tone dialing is required to access the features that PBX systems may offer.

Your Customer Service Representative sets your lines to pulse or tone dialing in Configuration programming.

To switch from pulse to tone dialing

#

If your external lines are programmed for pulse dialing, you can switch your telephone temporarily to tone dialing.

1. Press **#** while on an active line. Once you hang up, your telephone returns to pulse dialing.

Ring Type

Feature ***** **6**

You can choose one of four distinctive rings for your telephone. This makes it easier to identify your telephone in an open office.

1. Press **Feature** ***** **6**.
2. Choose the ring type you want.

This is the display you will see when choosing a ring type.

Ring type: 1
NEXT OK

Press **1**, **2**, **3**, **4** or **NEXT**. You hear the selected ring for two seconds. Repeat until you hear the ring you prefer, then press **Hold** or **OK**.

Ring Volume

Feature * 8 0

You can set the volume at which your telephone rings.

1. Press **Feature** * **8** **0**. The telephone will ring.
2. Press **Volume** to adjust the volume.

This is the display you will see while setting Ring volume.

Press VOLUME bar

Press either side of the volume bar (**Volume**) to adjust the volume.

Telephone Administration Lock

Telephone Administration Lock limits the ways in which you can customize your telephone. There are three types of Telephone Administration Lock: Full, Partial, and None.

Full Administration Lock lets you change the contrast of your telephone's display, use Ring Type, Ring Volume and Button Inquiry, and control the volume of your speaker.

Partial Administration Lock allows you to forward your calls, turn on Do Not Disturb and Service Modes, and use the Background Music, Send Message, Ring Again, Privacy, and Trunk Answer features.

None (No Administration Lock) allows you to access all features that are programmed for your telephone. The System Coordinator assigns Administration Lock to each telephone in Administration programming.

Telephone Administration Lock does not affect call handling features.

Related features

Autodial

Feature * 1 / Feature * 2

You can program your telephone's memory buttons to dial frequently used numbers with the **Autodial** feature.

Feature programming

Feature * 3

You can program feature codes onto **your** telephone's memory buttons using the Feature programming feature,

Speed Dial programming

Feature * 4

You can program personal speed dial numbers onto speed dial codes 71 to 94 using the Personal Speed Dial programming feature.

Dialing

One of the most important features of your telephone system is the ability to dial telephone numbers. Many features require you to dial telephone numbers. The displays associated with dialing are listed here.

Direct-dial

You can dial a Direct-dial telephone with a single digit. The Direct-dial telephone is usually in a central location, such as a receptionist's or secretary's desk. It is usually a Prime telephone and a Central Answering Position (CAP).

External line access code

The external line access code is the number you dial to get an external line. You will need to use an external line access code if your Prime line is an internal line. The code will connect you to a line pool through your internal line.

If your Prime line is an external line, or if you select an external line on your telephone, you will not need an external line access code. You will always need an external line access code on an M7100 Telephone.

Your Customer Service Representative assigns the external line access code in Configuration programming.

Last Number Redial

5 Feature

You can redial the last external number you dialed.

1. Press **Feature** **5**.

Ring Again

Feature 2

If you can't get through to someone on your Norstar system because their telephone is busy or there is no answer, you can have the Norstar system tell you when they hang up or next use their phone.

1. Press **Feature** **2** before you hang up.

You can also use Ring Again to tell you when a busy line pool becomes available.

Using Ring Again cancels any previous Ring Again requests at your telephone.

Cancel Ring Again

Feature [] # [2]

You can cancel a ring again request by entering the Cancel Ring Again feature code.

Saved Number Redial

Feature [] 6 [7]

You can save the number of the external call you are on (providing you dialed the call) so that you can call it again later.

1. Press Feature [] 6 [7] while you are still on the call.

You can dial a saved number.

1. Press Feature [] 6 [7] when you are not on a call.

Related features

Autodial

Feature [] * [1] / Feature [] * [2]

The autodial feature lets you program telephone numbers onto memory buttons for one-touch dialing.

Dialing modes

Feature [] * [8] [2]

Norstar supports three different methods of dialing. They are described in the Customizing your telephone section under the heading Dialing Modes.

Line Pools

Line pools give you access to many external lines.

Priority Call

Feature [] 6 [9]

If you get a busy signal when you call someone in your office, you can interrupt them using Priority Call.

Speed Dial

Feature 0

The Speed Dial feature lets you dial programmed numbers by entering speed dial codes.

Displays

You will see some of these displays while selecting lines and dialing telephone numbers and in response to the numbers you dial.

A rectangular display box containing the text '9_' on the top line and 'QU' on the bottom line. A cursor is positioned to the right of 'QU', and a 'BKSP' key indicator is shown to the right of the cursor.

You are dialing using Pre-Dial. To erase an incorrect digit, press **BKSP** or ⇒ . When the number is complete, select a line or lift the receiver.

A rectangular display box containing the text '21 busy' on the top line and 'PRIORITY LATER' on the bottom line.

The telephone you have called has no internal lines available. You may press **LATER** to use the Ring Again or Message features or press **PRIORITY** to make a Priority Call.

A rectangular display box containing the text '95551234' on the top line and 'TRANSFER' on the bottom line.

This prompt remains on your display as long as you are on a call you have dialed. You may transfer the call by pressing **TRANSFER**.

A rectangular display box containing the text 'Already joined' on the top line.

Your telephone is already connected to the telephone you are trying to call. Check your active line buttons, and return to that call.

A rectangular display box containing the text 'Calling 21' on the top line and 'LATER' on the bottom line.

Wait for the telephone to be answered, or press **LATER** to use the Ring Again or Messages features.

A rectangular display box containing the text 'Call ing 21' on the top line and 'PRIORITY LATER' on the bottom line.

Wait for the telephone to be answered. If no one answers, you may press **LATER** to use the Ring Again or Messages features, or press **PRIORITY** to make a Priority Call.

Can't ring again

You cannot use Ring Again on your current call. You can only use Ring Again while you have a busy signal on an internal call or line pool request or while an internal call is ringing.

Do not disturb
PRIORITY LATER

The telephone you are calling is in Do Not Disturb mode. Press **LATER** to use the Ring Again or Messages features, or press **PRIORITY** to make a Priority Call.

In use: 21

The line you have chosen is in use at another telephone. Use a different line, or wait until the line is free.

Invalid number

You have entered a number that does not exist.

Line denied

You have attempted to use someone else's private line.

Line in use

The line you have chosen is in use. Try another.

Line 01
TRANSFER

Enter the: digits of the number you want to dial.

No button free

You have tried to make or receive a call when no line button was available.

No last number

You have not dialed an external telephone number since the last power interruption or system reset.

No line selected

Either you have no Prime line or your Prime line is busy. Select a line manually before dialing.

No number saved

You have tried to save the number of an incoming call. You can only save numbers that you have dialed yourself.

No saved number

You have tried to use Saved Number Redial, but have not first saved a telephone number. The Saved Number Redial memory is empty.

Not in service

You have entered the number of a telephone that is not in service.

On another call
LATER

The telephone you have called is on another call. Press **LATER** to use the Ring Again or Message features.

Restricted call

The call you are trying to make is not allowed for your Class of Service. Make your call on a line or telephone that is not restricted, or use a Class of Service password to bypass the restriction.

Ring Again?
YES NO EXIT

Press **YES** to use Ring Again. Press **NO** if you prefer to send a message. See Message and Ring Again.

Select a line

Either you have no Prime line, or the Prime line is in use, or the line programmed onto an Autodialer, Speed Dialer, or Hotline is in use. Select a line and dial again.

Send message?
YES NO

Press **YES** to send a message. See Messages.

Your number

You have dialed your own number.

Notes

The maximum number of digits that Last Number Redial or Saved Number Redial records is 24.

You can copy the telephone number from a Last Number Redial or Saved Number Redial button onto an Autodial button. Simply enter the Last Number Redial or Saved Number Redial feature code when the Autodial feature asks you to enter a number.

Each telephone can save only one number at a time with Saved Number Redial, not one number for each line.

Do Not Disturb

 Feature 8 5

Do Not Disturb

You can stop calls from ringing at your telephone.

1. Press Feature 8 5 .

Only Priority Calls will ring at your telephone. A line button will flash when you receive a call, but the call will not ring.

You can refuse to answer a particular call (including a Priority Call).

1. Press Feature 8 5 while your telephone is ringing.

Cancel Do Not Disturb

 Feature # 8 5

You can cancel Do Not Disturb.

1. Press Feature # 8 5 .

Displays

Do not disturb

Your telephone is in Do Not Disturb mode. To cancel Do Not Disturb, press Feature # 8 5 .

Allow calls

Your telephone is receiving calls normally.

Notes

If you use Do Not Disturb while an external call is ringing, the call will be forwarded to the Prime telephone. It may also be answered by anyone whose telephone shares the line it is on. Once you turn Do Not Disturb on, calls will be forwarded to the Prime telephone only if there is no other telephone on which the line appears. (The Delayed Ring Transfer feature transfers all unanswered calls to the Prime telephone after a specified time.)

Feature Programming

Feature * 3

Program a button

You can program a feature code onto a memory button.

1. Press **Feature** * **3**.
2. For all telephones other than the M7100 Telephone, select the button you want to program.
3. Enter the feature code you want to program onto the button.

Erase a button

Feature * 1

You can erase a memory button.

1. Press **Feature** * **1**. This is actually the External Autodial feature code.
2. For all telephones other than the M7100 Telephone, select the button you want to erase.
3. Erase the button by pressing **OK** or **[Hold]**.

You cannot erase Answer, Handsfree/Mute, Intercom, or line buttons.

Button Inquiry

Feature * 0

You can check the function of any line, Intercom, or memory button on your Norstar telephone.

1. Press **Feature** * **0**.
2. For all telephones other than the M7100 Telephone, press the button you want to know about.
3. Read the display.

When you are labeling or replacing a button cap, activate Button Inquiry so that you won't accidentally activate a feature.

Displays

You will see some of the following displays while programming, erasing, or checking buttons. A variety of displays appear in Button Inquiry. See the display <Feature name> for information applicable to these displays.

```
1234567890123...
VIEW→ OK
```

Press **#** to move either right or left, or press **VIEW→** or **←VIEW** to view a number that is too long to fit on the display. Press **Hold** or **OK** when you are finished.

```
<Feature name>
SHOW OK
```

The name of the feature assigned to a button is displayed when you press the button. **SHOW** appears when there is more information available. Press **#** or **SHOW** for additional information.

```
Enter code:
```

If you are checking a Speed Dial button, enter the two-digit Speed Dial code that you want to check,

```
Enter Digits
```

To erase a button, press **Hold**.

```
F_
QUIT CLEAR
```

While entering a feature code you can press **Feature** or **QUIT** to quit programming or **CLEAR** to clear out the characters you have entered. The system will accept the entry as soon as you enter a valid feature code.

```
Feature code:
QUIT
```

Press **Feature** and enter the feature code you want to program onto the button. Invalid codes cannot be entered.

```
Feature moved
```

You have programmed a button with a feature that was already programmed onto another button- The feature has moved to the button you just programmed. Its original button is blank.

```
Hold or release
```

You cannot program an autodialer or feature button while you are on a call.

Press a button
EXIT

Press the button you want to check.
Press or EXIT when you
are finished.

Program and HOLD

To erase a button, press [Hold].

Program and OK
QUIT OK

To erase a button, press r
press OK.

Release calls

You have tried to use Button Inquiry
while you were on a call or had calls
on hold.

Notes

When this book tells you to enter a feature code, you can do so by pressing a memory button programmed with that feature code. In some cases, pressing the button a second time cancels the feature.

On the M7100 Telephone, Button inquiry shows your internal number followed by the function assigned to your single memory button.

Any memory button not programmed as an external or internal line, Answer button, or Handsfree/Mute button, is available for programming features.

The following feature codes cannot be programmed onto a memory button: any code beginning with **Q** except Language Choice and Contrast Adjustment.

Group Listen

Feature 8 0 2

Group Listen

You can let people in your office listen in on a call.

1. Press Feature 8 0 2. You will hear the caller's voice through your telephone's speaker.
- 2; Continue to speak to the caller through the telephone receiver. The caller will not hear people in your office.

Cancel Group Listen

Feature # 8 0 2

You can cancel Group Listen for the current call.

1. Press Feature # 8 0 2.

Group Listen is canceled automatically when you hang up the Group Listen call.

Displays

You may see one of these displays with Group Listen.

Make call first

You have tried to use Group Listen when you are not on a call.

Pick up receiver

You have tried to use Group Listen without picking up the receiver.

Notes

Keep the receiver away from the speaker, or you may hear feedback. The higher the volume, the more the feedback. Press the Rls button to prevent feedback when hanging up.

You can switch a Group Listen call to Handsfree by pressing Handsfree . To switch back to Group Listen, enter the Group Listen feature code again,

Handsfree/Mute

Handsfree

Make calls without lifting the receiver

You can make calls without lifting the receiver. However, you must have a Prime line assigned to your telephone.

1. Press **Handsfree**. The telephone's internal microphone and speaker are automatically turned on.
2. Dial your call.
3. Speak normally.

Answer calls without lifting the receiver

You can answer calls without lifting the receiver.

1. When your telephone rings, press **Handsfree**. The telephone's internal microphone and speaker are automatically turned on if you have a Prime line assigned to your telephone.
2. Speak normally.

Mute Handsfree

You can switch off the telephone microphone so that you can speak privately to someone in your office while you are on a handsfree call.

1. Press **Handsfree**. The microphone is turned off.

You can turn the microphone back on again and continue your handsfree call.

1. Press **Handsfree**.

Regular call to Handsfree

You can turn any regular call into a handsfree call.

1. Press **Handsfree** and hang up the receiver.

Handsfree to regular call

You can turn a handsfree call into a regular call.

1. Lift the receiver.

Notes

The indicator next to **Handsfree** is solid when you are in Handsfree mode. It flashes when you mute the microphone,

In open-concept environments, use the receiver or a headset when Handsfree communication is not necessary, or when you need privacy during a call. Always tell the person you are speaking to that you are using Handsfree, and let them know who else is listening to the conversation.

Direct your voice toward the **telephone**. The closer you are to the telephone, the easier it is for the microphone to transmit your voice clearly to your listener.

Wait for your caller to finish speaking before you speak. The microphone and speaker cannot both be on at once. Your caller's voice may be cut off if you both speak at the same time. Noises such as a tapping pencil could be loud enough to turn on your microphone and cut off your caller's speech.,

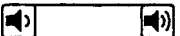
To prevent a possible echo, keep the area around your telephone free of paper and other objects that might screen your microphone. Turning down the microphone's volume (using ) also prevents echo.

Place the telephone so that any unavoidable local noise (such as an air conditioner) is behind it. This limits the amount of disruptive background noise.

A Handsfree button is assigned to a telephone by the System Coordinator in Administration programming.

The Handsfree/Mute feature is not available on M7100 Telephones.

Hold

Hold

Put a call on hold

You can temporarily suspend a call.

1. Press [Hold].

When a call is on hold, its indicator flashes on all telephones that have access to the line. The call can be retrieved from any of these telephones.

Retrieve a held call

You can connect to a call on hold.

1. Press the flashing line button of the held call.

Automatic Hold

You can switch from one call to another.

1. Press the line button of the caller you want to speak to. Your current caller is put on hold automatically.

Listen on Hold

If you have been put on hold, you can hang up the receiver while you wait for the other person to return.

1. Press [Hold].
2. Hang up the receiver.
3. Press the line button of the call. You may hear indications from the far end that you are on hold (for example, tones or music).
4. When the person you were talking to returns you will hear them through your telephone speaker. Lift the receiver and talk.

Exclusive Hold

Feature 7 9 or

Feature Hold

You can put a call on Exclusive Hold so that it can be retrieved only at your telephone.

1. Press Feature 7 9 or Feature Hold . The line appears busy on all other telephones, and the call cannot be picked up by anyone else in the office-

Mu&/Tones/Silence on Hold

External callers can hear either music, a periodic tone, or silence while they are on hold. In order for your caller to hear music, your company must have installed a music source.

WARNING

In accordance with U.S. copyright law, a license may be required from the American Society of Composers, Authors and Publishers, or a similar organization, if radio or TV broadcasts are transmitted through the Music on Hold feature of this telecommunication system.

Northern Telecom Inc. hereby disclaims any liability arising out of the failure to obtain such a license.

Your Customer Service Representative sets this feature to music, tones, or silence in Configuration programming.

Notes

On the M7100 Telephone, [Hold] alternates between two lines; one active, one on hold. The M7100 Telephone cannot retrieve a call placed on hold by another telephone.

If the Automatic Handsfree feature has been assigned to your telephone, use the Handsfree/Mute feature instead of Listen on Hold.

Host System Signaling

You can access Host systems, such as Private Branch Exchanges (PBX) from **Norstar** by using Host System Signaling features (also known as End-to-End Signaling). These features either send a special signal to the host system or allow you to program delays required by host systems onto external **Autodial** buttons or Speed Dial codes.

Host system signaling codes

Link

Feature 7 1

If your **Norstar** system is connected to a Private Branch Exchange (PBX), you can use a Link signal to access special features.

The Link signal can also be included as part of a longer stored sequence on an External **Autodial** button or in a Speed Dial code. The Link symbol () uses two of the 24 spaces in a dialing sequence.

Pause

Feature 7 8

The Pause feature enters a 1.5 second delay in a dialing sequence on an external line. This is often required for signaling remote devices, such as answering machines, or when reaching through to PBX features or Host systems.

You can obtain a Pause with one button press if you program the feature code onto a memory button. More than one Pause can be programmed onto an External **Autodial** button.

The Pause symbol () uses one of the 24 spaces in a dialing sequence.

For Pulse Dialing, * inserts a 1.5 second pause into the dialing sequence.

Programmed Release

Feature * 8 9

The Programmed Release feature performs the function of the **[Ris]** button in a programmed dialing sequence. When the system encounters Programmed Release in a programmed dialing sequence, it stops dialing and hangs up the call. The Programmed Release symbol (**[RS]**) takes up two of the 24 spaces in a programmed dialing sequence.

Run/Stop

Feature * 9

Run/Stop inserts a break'point into a sequence of dialed numbers or characters used for automatic dialing. This may be necessary when you are connecting to a PBX or similar Host system.

For example, you may call a company with an automated attendant that instructs you to dial the internal number you need. You can't program the company number, a Run/Stop, then the internal number on one External **Autodial** button. Press the autodialer once to dial the company number. When you hear the automated attendant, press the autodialer again to dial the internal number.

The Run/Stop symbol (S) uses one of the 24 spaces in an External Autodial or Speed Dial sequence.

Timed Release

Feature 7 2

The Timed Release feature inserts a 1.5 second pause into a sequence. You can use it in a dialing sequence for accessing a remote system, such as a PBX. You can also dial it if you wish to release a call from your line but keep the line for another call. You will return to dial tone.

The Timed Release symbol (**[TR]**) takes up two of the spaces in a programmed dialing sequence.

Displays

You may see this display while entering Host System Signaling codes.

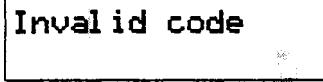

Invalid code

You have entered a code that can only be used in a programmed **Autodial** or **Speed Dial** sequence, not on a call you dial directly. Programmed **Release** and **Run/Stop** are for use in programmed dialing sequences only.

Notes

If your external telephone lines are programmed for Pulse Dialing, you can temporarily switch to Tone Dialing by pressing **I#** after selecting the line. Tone Dialing lets your **Norstar** telephone communicate with devices and services that respond to tone signals, such as automatic switchboards, and fax or answering machines.

Line Pools

Feature 6 4

Use a line pool

A line pool is a group of external lines that can be shared by many telephones- You can use a line in a line pool to make an external call.

1. If you have a free internal line, dial a line pool access code on an internal line. (You do not need the Line Pool feature code.) If you have no free internal line, press Feature 6 4 and then a line pool access code.

Everyone in the office should have a list of the line pool access codes for the line pools their telephones can use.

Displays

You may see some of the following displays while using a line pool. For displays associated with dialing telephone numbers, see the Dialing section.

Code:

Enter a line pool access code.

/Denied in admin

Access to the line pool you requested is denied in Configuration programming.

Invalid code

You have entered an invalid line pool access code.

Line in use

The line chosen by the system for your line pool request became active before connecting with your call. Retry the line pool request.

No button free

There is no free button on which the line pool line can appear.

No free lines

You have tried to access your line pool, but there are no lines in the line pool or all the lines are busy. Use Ring Again or call again later.

Notes

You do not usually need to enter the Line Pool feature code to use a line pool. Simply dial the line pool access code on an internal line. If you have no free internal lines, you will need to use the feature code to get a line pool. You will also need it to program access to a specific line pool onto a memory button.

You can program a button to access a line pool by programming the Line Pool feature code and a line pool access code onto a memory button in Feature programming ([*]). When all the lines in a line pool are busy, the indicator for the Line Pool button turns on. The indicator turns off when a line becomes available.

Your Norstar system can have three line pools, and a telephone can be programmed to access any number of them.

You can use a line pool only to make external calls.

If no lines are available in the line pool, you can use Ring Again at the busy tone. You will be notified when a line in the line pool becomes available. See Ring Again.

Your Customer Service Representative gives telephones access to line pools in Configuration programming. Each line pool is assigned a line pool access code in Configuration programming.

Messages

The Messages feature allows you to send a message to another Norstar user, and lets you know if you have any messages waiting. As well, the Messages feature uses a Message Waiting List to keep a record of your internal messages and your (external) voice mail messages, if the service is provided by your telephone company. From your Message Waiting List, you can:

- view your messages,
- call back the internal caller who left a message,
- erase an internal message,
- call your Voice Message Center that left a message(s), and,
- clear a message sent by your Voice Message Center (the message still remains at the Center until it is erased there).

Send a message

Feature **1**

You can leave a message on the display of another telephone in your Norstar system.

1. Press **Feature** **1**.
2. A one-line display shows **Message to:**
OR
A two-line display shows **Message 1 list**. Press **ADD** to display **Message to:**
3. Enter the internal number that is to receive your message. Your recipient's display identifies that the message has arrived.

Show your sent messages

1 **Feature**

On a telephone with a two-line display, you can show and scan the messages you have sent.

1. Press **Feature** **1**. The display shows **Message 1 list**.
2. Press **SHOW** to display your first sent message.

Cancel a sent message

Feature # 1

You can cancel a message that you have sent to someone.

1. Press Feature # 1. The display shows **Cancel** for:
2. Enter the internal number for the message that you want to cancel.

Notification of message(s)

If another user in your Norstar system or your Voice Message Center has sent you a message, your display reads **Message for** YOU or **Messages for** YOU. If you also have items in your Call Log, your display reads **Messages & Calls**.

Enter your Message Waiting List

Feature 6 5

To enter your Message Waiting List:

1. Press Feature 6 5. The display shows the first item.

Navigate through your Message Waiting List

To navigate forward through your list, press **NEXT** or #. To navigate backward, press **Q**.

Call from your Message Waiting List

From your Message Waiting List, you can call the person (or your Voice Message Service) who sent the message. First, you may want to view your messages and decide if you want to reply to them.

1. Press Feature 6 5. The display shows the first message.
2. Press **NEXT** or # to scroll through the list of messages.
3. To call a particular number, press **CALL** or 0. The telephone number that is dialed to access your Voice Message Center is programmed in Administration programming. This telephone number is dialed automatically when you press **CALL** or 0.

If you wish to use a line other than the programmed line, exit from the Message Waiting List and dial the Voice Message Center telephone number using normal dialing methods.

Remove items from your List

Feature # 6 5

You can erase an internal message or clear a message you have received from your Voice Message Center. When you clear this message from your Message Waiting List, it still exists at your Voice Message Center until you erase it there. To erase a voice message, refer to your Voice Message Center documentation.

1. From an idle telephone, press Feature # 6 5 to erase or clear the first message (either an internal message or a message from your Voice Message Center).

OR

From within your Message Waiting List, press CLEAR or ERASE or Hold for the item that you want to remove.

Related features

Call Log

The status display for the Message Waiting List shares the same display with the Call Log status display.

Displays

You will see some of the following displays while sending messages.

1.21
NEXT ERASE EXIT

When reviewing the messages you have sent, press NEXT to view the next message or ERASE to erase the message on the display.

21 called
NEXT CALL ERASE

This is the Message Waiting List display for internal messages. Press NEXT to see the next message. Press CALL to reply to the message. Press ERASE to erase the message.

Can't send ms9

You have tried to send a message to a Norstar Analog Terminal Adapter. The Norstar Analog Terminal Adapter does not have a display so it cannot show a message.

Cancel denied

You have entered an invalid number when attempting to cancel a message.

Cancel for:

Dial the internal number to which you sent the message you wish to cancel.

Cleared>LINENAM
NEXT

You have cleared an external message from your Message Waiting List. The message itself still exists in your Voice Message Center until you erase it there:

Erased> 21
NEXT

You have erased an internal message.

Hold or release

This message does not pertain to M7100 Telephones. If you try to access your Message Waiting List while on an active call, this display advises you to hold or release the present call.

In use: 21

You are trying to call from your Message Waiting List. The line that you are trying to use is being used by the identified **Norstar** user.

L01:LINENAM UMsg
NEXT CALL CLEAR

This is the Message Waiting List display. For that particular voice message, it tells you the line the call came in on, and the name of that line.

Message denied

You have tried to send a message to an invalid internal number or to a telephone that is out of service.

Message for you
MSG

You have a one **item** in your Message Waiting List, and you have no new entries in your Call Log. Press **MSG** to review the message.

Message list
SHOW ADD EXIT

The **SHOW** display button appears only if you have outstanding messages. Press **SHOW** to review or erase messages you have sent. Press **ADD** to send a new message.

Message to:

Enter the internal number of the telephone to which you would like to send a message.

Messages & Calls
MSG CALLS

This indicates that there is more than one item in your Message Waiting List, and there are one or more new entries in the Call Log.

Messages for you
MSG

You have more than one item in your Message Waiting List, and you have no new entries in your Call Log. Press **MSG** to review the messages.

No button free

You have no line button free with which to reply to a message.

No messages

You don't have any messages to cancel or there are no messages to scan through.

No number stored

There has been no number programmed for the Voice Message Center. To program the number, see the Programming chapter.

Release call s

If you have an M7100 Telephone, this is displayed when you try to reply to a message while on an active call. You must-release your call before entering your Message Waiting List.

Their list full

You are trying to send a message to a telephone whose message waiting list is full.

Your list full

You have tried to send a message but your telephone's list of sent messages is full. Cancel one of the messages you have sent, if possible, or wait until you have received a reply to one of those messages.

Notes

You can send up to four messages to different telephones, including your Voice Message Center. If your telephone is a Direct-dial telephone or a Central Answering Position, you can send messages to 30 telephones.

You can receive up to four messages from different telephones, including your Voice Message Center. The single message from your Voice Message Center may pertain to several voice messages.

Any message can be canceled either by the person who sent it or by the person who received it.

If your reply to a message is forwarded or is answered at another telephone using the Call Pickup feature, the message remains on your telephone until you cancel it or successfully contact the telephone that sent the message.

Norstar Telephones

This section covers the basic features of your Norstar telephone and optional equipment that may be attached to it.

Buttons

Feature button (Feature)

You use the Feature button to invoke **Norstar** features. See the Using Norstar features section.

Hold button [Hold]

You use the Hold button to put calls on hold. See the Hold section. It is also used in place of the **OK** display button on telephones with one-line displays.

Memory buttons

Memory buttons are the buttons with indicators on the M7208, M7310, and M7324 Telephones, and the dual buttons without indicators on the M7310 Telephone. There is also a single memory button, without an indicator, on the M7100 Telephone. Memory buttons can be used for any of the following buttons, except that lines and Answer buttons must appear on buttons with indicators.

Answer buttons

You can use an Answer button to monitor calls on another person's telephone. All calls to the monitored telephone appear on the Answer button. Such calls may also ring at the telephone with the Answer button, depending on how the system is configured. Answer buttons are most useful for a secretary who monitors incoming calls for one or several managers.

If more than one call is ringing at the manager's telephone, the first call appears on the secretary's Answer button. Any subsequent calls appear on Intercom buttons if they are available.

More than one secretary may have an Answer button for a single manager. This allows two or more secretaries to handle calls for a busy manager.

Similarly, one person can handle calls for up to four other people, using separate Answer buttons for each person.

A secretary's telephone should have a memory button with an indicator programmed as the Internal **Autodial** button for the manager's telephone. This allows the secretary to call the manager and to deal efficiently with incoming calls.

You cannot make calls using Answer buttons.

Autodial buttons

Autodial buttons let you dial numbers by pressing a single button. See the **Autodial** section.

Line buttons

You have one line button for each line assigned to your telephone. You press the line button to select the line you want to answer or use to make a call. Having several line buttons allows you immediate access to more than one line so you can handle and monitor calls easily. The **M7100** Telephone does not have line buttons and can have a maximum of two lines. You can switch between its two lines, one active and one on hold, by pressing **[Hold]**.

Programmed Feature Buttons

Programmed feature buttons allow you to invoke Norstar features by pressing a single button. See the **Feature Programming** section.

Release button

[Ris]

Pressing **[Ris]** ends a call. You do not have to put the receiver down. **[Ris]** also ends feature programming.

While you are on a call, do not press **[Ris]** to end a feature you are using (such as Show Message). If you do, you will disconnect the call. Use **[Feature]** instead.

Volume Bar



The Volume Bar controls the volume of the receiver, telephone ring, Handsfree speaker, headset and Background Music. Press either end of the volume bar () to adjust the volume.

Headset

A headset lets you keep both hands free while you are on a call without others overhearing your telephone conversations.

If you plug a headset into your telephone while you are on a call, your telephone's microphone and speaker (or your receiver if you are on a regular call) are turned off and your headset microphone and earpiece are turned on.

You must have the **Handsfree/Mute** feature assigned to your telephone if you wish to use a headset.

While you are using the headset, the receiver and the switch in the telephone cradle do not work.

A headset cannot be used on an M7100 Telephone.

Using a headset

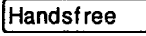
While on a call using the headset, press  to turn your headset on and off.

To answer a call, press .

To adjust the volume, press the appropriate side of the volume bar ()

To change to a Handsfree call while you are on a call using your headset, unplug your headset. Your telephone's microphone and speaker turn on and the call becomes a Handsfree call. (It is a good idea to put the call on hold while you do this.)

You may see this prompt when you try to use a headset.

Need Handsfree

You are attempting to use a headset, but Handsfree/Mute is not programmed for your telephone. If you are not using a headset, you have accidentally plugged your telephone receiver into the headset outlet on the bottom of the telephone.

Hearing Aid Compatibility

The receivers on all Norstar telephones are compatible with hearing aids as defined in the FCC rules, Part 68, section 68.316.

Note: Not all hearing aids are optimized for use with a telephone.

Wall Mounting

Most Norstar telephones can be mounted on a wall. Contact your Customer Service Representative if you wish to have any telephones in your system wall-mounted.

Page

Feature 6 0

Make a page announcement

You can make announcements over the Norstar system.

1. Press Feature 6 0.
2. Choose a page type.
3. If necessary, choose a zone.
4. Make your announcement.
5. Press Ris.

Page types are :

- 1 through the telephone speakers (Internal Page)
- 2 through an external speaker (External Page)
- 3 both Internal and External (Combined Page)

Paging shortcuts

Instead of entering the Page feature code followed by the page type, you can enter the following shortcut codes.

Internal Feature 6 1 and zone (0 to 6)

External Feature 6 2 (code 2 has no zones)

Combined Feature 6 3 and zone (0 to 6)

Related features

Voice Call

Feature 6 6

You can make an announcement to one person by placing a voice call to their telephone.

Displays

You will see some of these displays while making a Page announcement.

Denied in **admin**

You have tried to Page, but this feature has not been assigned to your telephone.

Enter zone:
ALL

Enter the desired zone number (0-6) or press **ALL** to page to all zones. (0 equals all zones.)

Invalid zone

You have entered a page zone code that is not between 0 and 6.

Page choice:
SETS SPKR BOTH

Select the type of page you want by pressing:

1 or **SETS** — Internal Page

2 or **SPKR** — External Page

3 or **BOTH** — Combined Page

Page timeout

The time allotted for paging has expired.

Paging **FILL**

The prompt appears while you are paging and shows the page zone you have chosen. Press **Feature** or **Fls** when you are finished paging.

Paging busy

A page is already being made in the page zone you have requested.

Notes

Page zone 0 equals all zones.

Each Norstar telephone can be assigned access to Paging and is assigned to one of six page zones, or to none, in Administration programming.

Make sure that everyone who needs to make page announcements has a list showing which telephones are in which page zones.

Priority Call

Feature 6 9

If you get a busy signal when you call someone in your office, you can interrupt them. Use this feature for urgent calls only.

1. Press Feature 6 9 .
- 2.. Wait for a connection, then speak.

A person who receives a Priority Call while on another call has eight seconds to accept or reject the call. If the person does nothing, the Priority Call feature puts the active call on Exclusive Hold and connects your call.

Displays

You will see some of these displays while making a Priority Call.

Call blocked

You tried to place a Priority Call to another **Norstar** telephone. The person you called has blocked your call. Try to call later.

Denied in admin

You have tried to make a Priority Call, but this feature has not been assigned to your telephone.

Make call first

You have attempted to use the Priority Call feature with no ringing or busy tone on the line. Use Priority Call only when you hear ringing or a busy signal.

Please wait

The party you are calling has eight seconds to decide whether to accept or reject your Priority Call.

Priority denied

The telephone you are calling is already in a Priority Call or is unable to receive Priority Calls.

Notes

You can make a Priority Call only while your telephone display shows one of the following prompts:

Do not disturb PRIORITY LATER

On another call PRIORITY LATER

Calling 21 PRIORITY LATER

21 busy PRIORITY LATER

If Call Forward is active at the telephone you are trying to reach, your call will be forwarded.

If the telephone receiving the Priority Call is in a conference call, the other two parties are automatically put on hold when the Priority Call is accepted.

The System Coordinator gives a telephone permission to make Priority Calls in Administration programming.

Service Modes

Feature 8 7

Switch to a service mode

You can use Service Modes to make your Norstar system behave differently at different times of day. For instance, all incoming external calls can be directed to a security guard's telephone during the night, or calls to one receptionist can be directed to another receptionist during lunch.

1. Press Feature 8 7 on a Control telephone. (See Special telephones for information on Control telephones.)
2. Select the service mode you want.

Cancel Service Modes

Feature # 8 7

You can return to normal operation or cancel the manual override of an automatic mode. You cannot cancel an automatic mode.

1. Press Feature # 8 7.

Displays

You will see some of the following displays when selecting a service mode.

```
Night Service
QUIT  OK  NEXT
```

The name of the current service mode ("Night Service", in this case) is displayed. Press # or NEXT to see other service mode options. Press Hold or OK to select the desired mode.

```
Denied in admin
```

You are trying to activate a service mode from a telephone that is not a Control telephone or Direct-dial telephone, or else all service modes are disabled in Administration programming.

Notes

A service mode allows you to change which lines ring at which telephone, to activate or deactivate the auxiliary ringer for certain lines, and to have Direct-dial calls ring at the Extra-dial telephone. Service modes can be programmed to begin automatically at certain times or they can be turned on and off at the Control telephone. The System Coordinator sets up service modes in Administration programming.

Automatic service modes are indicated by an asterisk (*) before the name of the service mode on the display. You can neither manually activate nor cancel automatic service modes, although you can override them with manual modes.

The Control telephone can override automatic service modes at any time by entering the Service Modes feature code ([Feature]), and selecting a different service mode; this override will remain in effect until it is canceled by means of . Note that if you selected a service mode with an asterisk (*), the next automatic service mode will come into effect at the programmed time.

Direct-dial calls to a Direct-dial telephone will ring at the Extra-dial telephone (designated in Administration programming) only when the Service Modes feature code () is entered at that Direct-dial telephone. Note that only the Extra-dial telephone will be activated, not the actual service mode (unless that Direct-dial telephone is also a Control telephone).

Norstar provides three service modes named "Night", "Lunch", and "Evening". You can change these names to suit yourself. In addition, there is normal service when no service modes are active.

Special Telephones

You can assign several special functions to the telephones in your Norstar system. Except where noted, you do not need special hardware. A special function is assigned to a telephone either by your Customer Service Representative in Configuration programming or by the System Coordinator in Administration programming.

Control telephone

The Control telephone lets you place the external lines for which it has responsibility into and out of Service Modes. See Service Modes.

Direct-dial telephone

You can dial a Direct-dial telephone with a single digit. The Direct-dial telephone is usually in a central location, such as a receptionist's or secretary's desk. It is usually a Prime telephone and a Central Answering Position (CAP).

There may be up to five Direct-dial telephones in your system, but each telephone in the system is assigned to a single Direct-dial telephone. There is a single Direct-dial digit for the whole system that lets each telephone call its assigned Direct-dial telephone.

Each Norstar Direct-dial telephone can send up to 30 messages and each can invoke Service Modes to activate the Extra-dial telephone.

Your Customer Service Representative sets up Direct-dial telephones in Configuration programming. The System Coordinator assigns telephones to Direct-dial telephones in Administration programming.

Emergency telephone

The Emergency telephone is a single-line telephone (not a Norstar telephone) that functions independently of the Norstar system. You can use the Emergency telephone when your Norstar system is not working.

Emergency Transfer/Power Failure Cut-through provides basic telephone service on external line 01 through an Emergency telephone if the power fails or if a system error occurs.

The Emergency telephone is usually located near the Key Service Unit (KSU). Each KSU can support two Emergency telephones, and each Trunk Module can support one additional Emergency telephone.

Extra-dial telephone

In Service Modes, a second telephone can be assigned to ring on calls made to a Direct-dial telephone. There may be one Extra-dial telephone for each Direct-dial telephone, and it may be a different telephone in each Service Mode.

Hotline telephone

You can call a programmed internal or external telephone number simply by picking up the receiver of the Hotline telephone (or by pressing **Handsfree**).

A Hotline telephone can be set up to dial an operator or an emergency number. You should put a notice by the Hotline telephone to let people know which number will be dialed when they lift the receiver.

If the Hotline telephone is set up to dial an external number using the Prime line, there must be an external Prime line assigned to the telephone. If not, the Hotline call will fail.

The System Coordinator sets up the Hotline telephone, the telephone number it dials, and the line on which that number is dialed, in Administration programming.

To bypass a Hotline

Press a line button, or use the Pre-Dial or Automatic Dial feature before you pick up the receiver or press **Handsfree**.

The following displays may occur at a Hotline telephone.

Line in use

The line assigned to the Hotline is in use. Make the call using normal methods or wait until the Hotline line is free.

[NO 1 line selected

The Hotline has been set up to dial an external number on a Prime line but the Hotline telephone does not have a Prime line. This must be corrected in Configuration or Administration programming.

No free lines

The Hotline has been set up to dial an external number on a Prime line but the Hotline telephone has an internal Prime line and no access to line pools. This must be corrected in Configuration or Administration programming.
This message may also appear if the line pool assigned to the telephone is busy.

Prime telephone

Each line in a Norstar system can have a telephone assigned to it as a Prime telephone. Calls not answered at their normal destinations are transferred to the Prime telephone. The Prime telephone is usually the telephone on the receptionist's desk and it is often the Control telephone and a Central Answering Position as well. A Prime telephone is assigned to a line in Configuration programming.

See the Answering the telephone section for the displays that may occur at a Prime telephone.

Speed Dial

Feature 0

Make a Speed Dial call

You can quickly dial external telephone numbers that have been programmed onto Speed Dial codes.

1. Press **Feature** **0**.
2. Enter the appropriate two-digit Speed Dial code.

Norstar supports two types of Speed Dial codes, Personal and System. System Speed Dial codes are from 01 to 70. The System Administrator can assign numbers to System Speed Dial codes for the entire system in Administration programming. Personal Speed Dial codes are from 71 to 94 and may have different numbers assigned to them on each telephone. Users can program their own Personal Speed Dial numbers.

Program Personal Speed Dial

Feature * 4

You can add or change a Personal Speed Dial number on your telephone.

1. Press **Feature** ***** **4**.
2. Enter the code that you want to associate with a telephone number.
3. If you want to include a line selection for this number, select the line or line pool. For the M7100 Telephone, you can select a line only.
4. Enter the number you want to program.
5. Press **OK** or **[Hold]**.

Displays

You will see some of these prompts while using or programming Speed Dial.

9_
QUIT BKSP OK

Continue entering the number you wish to program. You can change the number by pressing the left side of the volume bar or by pressing **BKSP**.

When you are finished, press

Hold or **OK**.

Access denied

You have tried to program a Personal Speed Dial number while someone else on the system is in Configuration or Administration programming.

Autodial full

You have tried to enter a new Personal Speed Dial Number, but the memory for these numbers in your **Norstar** system is full.

Enter code:

Enter a two-digit code between 71 and 94 for the personal speed dial number you want to program.

Enter digits
QUIT OK

Enter the telephone number you wish to program exactly as you would if you were dialing it normally. When you are finished, press **Hold** or **OK**.

Invalid code

You have entered a code outside the code range (01-94).

Line in use

The line associated with the speed dial number you are trying to use is busy.

No number stored

There is no number stored on the Speed Dial code you have dialed.

Program and HOLD

If you want to program a line or line pool selection for this Speed Dial, select the line or line pool. Otherwise, enter the telephone number you wish to program exactly as you would if you were dialing it normally. When you are finished, press **[Hold]**.

Program and OK
QUIT OK

If you want to program a line or line pool selection for this Speed Dial, select the line or line pool. Otherwise, enter the telephone number you wish to program exactly as you would if you were dialing it normally. When you are finished, press **[Hold]** or **OK**.

Select a line

There is no line associated with the speed dial number you are trying to use. Select a free external line or line pool and enter the Speed Dial feature code again.

Speed dial >

Enter a two-digit Speed Dial code (01-94). You must enter the zero for codes 01 to 09.

Notes

There is no difference between using Personal Speed Dial and using System Speed Dial. They differ only in how you program them.

Speed Dial numbers' may include line choices and Host System Signaling codes.

Speed Dial numbers are subject to the same Class of Service as regularly dialed numbers. System Speed Dial numbers can be programmed to bypass dialing restrictions.

Normally, Speed Dial numbers are shown on the display while they are being dialed. System Speed Dial numbers may be programmed to show a Speed Dial name instead of the number, keeping the actual number confidential.

System features

The following features are available for the entire Norstar system.

Accidental Disconnect Protection

If you accidentally drop the receiver back into the telephone cradle while answering a call, you can quickly retrieve the call.

1. Pick up the receiver again or press **Handsfree**. You are connected to your call.

Automatic telephone relocation

If Automatic telephone relocation is enabled, you can move your telephone from one **Norstar** jack to another without it losing any of its custom programming. Your Customer Service Representative enables Automatic telephone relocation in Configuration programming.

Background Music

Feature **8** **6**

You can listen to music through your telephone speaker.

1. Press **Feature** **8** **6**.

WARNING

In accordance with U.S. copyright law, a license may be required from the American Society of Composers, Authors and Publishers or a similar organization if radio or TV broadcasts are transmitted through the Background Music feature of this telecommunication system.

Northern Telecom Inc. hereby disclaims any liability arising out of the failure to obtain such a license.

The music stops automatically if you make or answer a call.

Your Customer Service Representative makes this feature available to all telephones in Configuration programming. You will need to supply a music source, such as a radio, attached to your KSU.

Cancel **Background Music**

Feature # 8 6

You can cancel Background Music.

1. Press Feature # 8 6 .

Class of Service

The Class of Service for a call consists of all the Norstar features and lines available to you for that call. This is determined by the features assigned to the telephone in Administration programming, including all Dialing Filters.

Users who need to **dial** numbers not permitted by the Class of Service of the line or telephone that they are using, can switch to a different Class of Service by entering a Class of Service Password.

Internal numbers

Each telephone in the **Norstar** system has its own internal number. The length of internal numbers in your system may be 2 digits. All numbers in your system are the same length. Your Customer Service Representative sets the length of internal numbers (also called the DN length) in Configuration programming.

To find out your internal number, use the Button Inquiry feature (Feature * 0) on an internal line button. On the M7100 Telephone, Button inquiry shows your internal number followed by the function assigned to your single memory button.

Lines

The following features and characteristics are associated with the use of lines.

Line appearance

Any of the lines in your system may appear at any of your telephones. Your Customer Service Representative assigns lines to telephones in Configuration programming,

Usually, only the lines that are appropriate for a particular person appear at that person's telephone. When a line is assigned to a telephone it is automatically given a line button on that telephone, if a button is available. The M7100 Telephone has no line buttons for its lines.

Normally, you cannot answer a call that is ringing on a line that does not appear on your telephone. To pick up such a call, use Call Pickup, Call Park, or Transfer.

Line Pools

A line pool allows each telephone access to external lines from a group (or "pool") of external lines. You can access such lines by pressing an intercom button and entering a line pool access code or by pressing a memory button programmed with the line pool feature code.

Private lines

A Private line is exclusive to a particular telephone. Calls that are put on hold or left unanswered on a Private line cannot be picked up at any telephone except the Prime telephone.

Prime line

Your telephone can be programmed to select an internal or external line or a line pool automatically whenever you lift the receiver or press **Handsfree**. This is your Prime line.

Ringing Line Preference

Each telephone in the Norstar system can be programmed to ring or remain silent for incoming calls on any external lines that appear on the telephone.

For example, a telephone may have buttons assigned for lines 1 to 3, but have only lines 1 and 2 programmed to ring. An incoming call on any of the three lines causes a line button indicator to flash, and the telephone can be used to answer the call. This is especially useful for people who monitor other telephone lines, but want only their own lines to actually ring.

If a telephone has an external line as a Prime line, that line is usually made to ring.

System Speed Dial

Speed Dial codes 01 to 70 are the same for the entire system. See the Speed Dial section for details.

Time features

The Time features let you check the present time and how long you have spent on a call.

Call Duration Timer

Feature

You can see how long you spent on your last call or how long you have been on your present call.

1. Press .
2. Read the display.

Show Time

Feature

You can see the present date and time while you are on a call.

1. Press .
2. Read the display.

Displays

One of the following displays will occur when you use a Time feature.

Make call first

You have not made a call since your telephone's clock was last reset.

21 02:47

The display shows the last call you made, or the current call, and the total elapsed time in minutes and seconds.

Apr 9 9:54 am

The display shows the present time.

Transfer

[Feature] 7 0

Transfer a call

You can transfer a call to another person in your office.

1. Make or answer a call.
2. Press [Feature] 7 0 (or [Transfer] if programmed).
3. Dial an internal telephone number.
4. If you wish, you can announce the call after the called party answers.
5. Press [Ris] or JOIN.
6. The call is immediately transferred.

Note: You can also press a programmed Call Queuing button to complete the transfer and answer the next call.

Transfer using Hold

Transfer using Hold can only be used to transfer an external call to another telephone that has a button for the line that the external call is on.

Call the person you want to transfer the call to and tell them there is a call on hold for them. Do not enter the Transfer feature code. To accept the call, your co-worker presses the line button with the flashing indicator.

An M7100 Telephone can transfer a call using Hold but it cannot receive a call transferred in this way.

Displays

You will see some of the following displays while transferring calls.

121 busy
CANCL RETRV

The person to whom you tried to transfer a call is on another call. Press RETRV to enter a new internal number. On the M7100 Telephone, you will automatically be returned to the **Transfer** to: prompt.

21 DND
CALLBACK

The person to whom you tried to transfer an external call has Do Not Disturb active on their telephone. Press CALLBACK or the flashing line button to reconnect to the call. On the M7100 Telephone, lift the receiver.

21 hung up
CANCL RETRY

The internal caller you were trying to transfer hung up before the transfer was complete;

21 no reply
CALLBACK

The person to whom you tried to transfer a call did not answer. Press CALLBACK or the flashing line button to reconnect to the call. On the M7100 Telephone, lift the receiver.

22>22
CANCL RETRY JOIN

Press RETRY if, after talking to the person at internal number 21, you decide to transfer the call to someone else. Press RTS or JOIN to transfer the call from internal number 21 to 22.

Announce to:
CANCEL

Dial the internal telephone number of the person to whom you want to transfer the call. If you are already connected to that person, press the line button of their call.

/Cal; transferred

Transient message to indicate that the transfer was successfully completed.

Do not disturb
CANCL RETRY JOIN

The person to whom you tried to transfer an internal call has Do Not Disturb active on their telephone. Press **CANCL** or the flashing line button to reconnect to the call. On the M7100 Telephone, enter the transfer cancellation code ([Feature] # 7 0) to reconnect to the call.

Invalid number
CANCL RETRY

An invalid DN has been entered, or the transfer feature has been invoked before the complete DN has been entered.

Line 01 hung U P

The external caller you were trying to transfer has hung up before the transfer was complete.

Line 01>21
CANCL RETRY JOIN

Press **JOIN** to transfer the call on line 01 to telephone 21. Press **RETRY** if, after talking to the person at internal number 21, you decide to transfer the call to someone else.

Make call first

You have tried to use the Transfer feature when you have no call to transfer.

Not in service
CANCL RETRY

The telephone to which you are trying to transfer a call is out of service.

Restricted call
CANCL RETRY

You cannot transfer the call because of telephone or line restrictions.

Still in transfer
CANCL RETRY

Once you have invoked the transfer feature you must complete the transfer actions before you can access a new feature, answer another alerting call or select an outgoing line.

Transfer denied
CANCL RETRY

Your transfer cannot be completed for one of these reasons:

- All the internal resources needed to perform a transfer are in use. Try again later.
- You have tried to transfer an external call to another external party.

Transfer to:
CANCL RETRY

Press **RETRY** if you entered the wrong internal number or if the person you are transferring the call to is unavailable.

Notes

If an external call is transferred to a busy internal line, or not answered after a few rings, the call automatically rings you back and the display indicates that the line was busy or that no one answered,

Voice Call

Feature 6 6

Make a voice call

You can make an announcement or begin a conversation through the speaker of another telephone in the system.

1. Press Feature 6 6 .

Mute Voice Call tones

When a Voice Call begins at your telephone, you hear a beep every 15 seconds as a reminder that the microphone is on. You can stop it beeping.

1. Pick up the receiver or press Handsfree .

Handsfree **Answerback**

If Handsfree Answerback is assigned to your telephone, you can respond to a Voice Call without touching the telephone.

1. When someone makes a Voice Call to you, simply start talking. Your telephone's microphone picks up your voice.

Your telephone will beep periodically to remind you the microphone is on. You can stop it beeping.

1. Pick up the receiver or press Handsfree .

Voice Call Deny

Feature 8 8

You can prevent your telephone from receiving Voice Calls.

1. Press Feature 8 8 . Voice Calls will ring like regular internal calls. Your other calls will proceed normally.

Cancel Voice Call Deny

Feature # 8 8

You can cancel Voice Call Deny.

1. Press Feature # 8 8 .

Displays

You will see some of these displays while making a Voice Call.

/Dial voice call

Dial the internal number or press the internal **Autodial** button of the person to whom you want to speak.

Voice call

The line is open for you to speak.

No voice call

The telephone receiving the call cannot accept Voice Calls for one of the following reasons: it is active or ringing with another call; it is in Call Forward mode; it is in Do Not Disturb mode; it has Voice Call Deny turned on; it is not a **Norstar** telephone.

Your call proceeds automatically as a regular ringing call.

Notes

Once you have answered a Voice Call, you can put it on hold, transfer it, or otherwise treat it as a normal call.

When you have Handsfree Answerback assigned to your telephone, and you are using an on-hook Dialing Mode, the microphone and speaker are both activated for external calls.

The System Coordinator assigns Handsfree Answerback to a telephone in Administration programming. You can not assign Handsfree Answerback capability to the M7100 Telephone.

Using Norstar features

Using a Norstar feature

1. Press **Feature** , and enter the desired feature code on the dial pad.
OR
Press the programmed memory button.
2. Follow the display messages.

Note: On M7310 and M7324 Telephones, some features are also available on the display buttons.

Programming a Norstar feature on a memory button

1. From an idle telephone, or with your calls on hold, press **Feature** * .
2. Press the memory button that you want to program. (This step is not required on the M7100 Telephone.) See your telephone user card for the location of the memory buttons.
3. Enter the feature code you want to program.

Personalizing your telephone

Autobumping

Feature

Allows the oldest log entry to be deleted from a full Call Log when a new item is logged, so that the new log entry can be stored. For more information, see Call Log.

Cancel **Feature**

Background Music

Feature

Allows you to listen to music (provided by your office) through your telephone speaker when you are not on a call.

Cancel **Feature**

Button Inquiry

Feature

Checks what is programmed on any button. Use this feature when labeling memory buttons.

Call Log Password

Feature

Enter a password for your Call Log. To remove the password, see your System Coordinator.

Class of Service

Feature

Overrides the Class of Service on a telephone to allow you to make a call from that telephone. The Class of Service determines which numbers you can dial. Switch from one Class of Service to another using this feature code and a password provided by your System Coordinator.

Contrast Adjustment

Feature

Adjusts the contrast of your telephone display. Press through (depending on your telephone).

Dialing Modes

Feature

Changes the on-hook Dialing Modes. The three Dialing Modes are:
Automatic Dial: If you have a Prime line, dial a telephone number without pressing a line button. A line is selected automatically.
Pre-Dial: Dial a telephone number. Edit it by pressing **BKSP**, or the left side of . Press a line button to place the call.
Standard Dial: Press a line button, then dial a telephone number.

Do Not Disturb

Feature

Prevents incoming calls from ringing at your telephone.

Cancel **Feature**

166 / Compact DR5 Telephone Feature Card

Language Choice	Feature * 9 0 0	Select English language for the telephone display.
	Feature * 9 0 1	Select alternate language for the telephone display.
Moving Line Buttons	Feature * 1 0 0	Change the position of a line button. Remember to switch the button caps after the line button is moved. Lines cannot be moved to positions occupied by Intercom , Handsfree , or Answer buttons. This feature is not available on the M7100 Telephone.
Programming Call Log	Feature * 6 0 0	Select the type of calls that will be automatically stored in your Call Log.
Programming memory buttons	Feature * 1	External Autodial: Stores a line (optional) and an external telephone number onto a memory button for one-button access to that number.
	Feature * 2	Internal Autodial: Stores an internal telephone number onto a memory button for one-button access to that telephone number.
	Feature * 3	Program Features: Stores a feature onto a memory button for one-button access to that feature.
Note: Line , Intercom , Answer , or Handsfree cannot be programmed.		
Programming a feature button:		
<ol style="list-style-type: none"> 1. Press Feature * 3. (For M7100 Telephones, go to step 3.) 2. Press the memory button you want to program. 3. Enter the feature code of the feature you want to program. 4. If you entered the Line Pool feature code in step 3, enter the access code for a line pool. 		
Ring Type	Feature * 6	Selects a distinctive ring to help differentiate between your telephone and others nearby. Enter the feature code and press NEXT or 1 through 4 to select the new Ring Type. Press Hold or OK to store the new ring.
Ring Volume	Feature * 8 0	Makes your telephone ring so you can adjust the volume, even while you are on a call.
Run/Stop	Feature * 9	When using the External Autodial programming feature, inserts a break point between two or more numbers stored on a memory button. Press the memory button once to dial the first number; a second time to dial the second number, and so on.

Speed Dial

Feature

Personal: Programs a telephone number into a Personal Speed Dial code (from 71 to 94).

Programming a Personal Speed Dial code:

1. Press to enter Personal Speed Dial codes.
2. Enter a two-digit code (from 71 to 94).
3. To program a line as part of the Speed Dial code, press a line button or a line pool button.
4. Enter the telephone number to be assigned to that code. Telephone numbers cannot exceed 24 digits.
5. Press or to finish programming.

Voice Call Deny

Feature

Prevents your telephone from receiving Voice Calls, permits only ordinary ringing calls.

Cancel

Remote system signaling

Link Link signal (also called flash or recall) on an active line to access other systems or carriers.

Pause When programmed in an External **Autodial** sequence, inserts a 1.5second delay in a number being dialed.

Feature

Far Pulse and Tone Dialing

For Pulse Dialing only

Programmed Release

When programmed at the end of an External **Autodial** sequence, performs the same function as .

Timed Release

Feature

Generates a longer Link signal (1.5 seconds) on an active line. Use this feature when you want to release a call on your line but retain the use of the line for another call.

System features

Call Duration Timer	Feature 7 7	Briefly displays the length of your current call. If your telephone is idle, the length of your most recent call is displayed.
Call Log	Feature 6 1 2	<p>Log to view stored caller information. The Call Log displays use special characters.</p> <ul style="list-style-type: none"> 1 A new item in the Call Log is underlined. 2 Answered calls are identified. 5 Long distance calls are identified. ✓ The displayed information has been truncated. <p>Note: Call Log is only available if you have subscribed to Call Display services from your local telephone company.</p> <p>Calling from your Call Log:</p> <ol style="list-style-type: none"> 1. Navigate to the appropriate log item, and display the number. 2. Edit the number, if required. The leading digits may need to be trimmed, or digits may need to be added for Long Distance or line pool access. See your System Coordinator. 3. Press a line button. 4. Lift the receiver.
Message	Feature 6 5 Feature 1	<p>Reply to Message: Review your list of external and internal display messages, and return calls. Cancel Feature # 6 5</p> <p>Send Message: Leave a message on a co-worker's telephone display to call you back. Cancel Feature # 1 1</p>
Page	Feature 6 0 Feature 6 2 Feature 6 3 Feature 6 1	<p>Allows you to make announcements through either the internal or external speakers, or both. Enter the feature code, the page code (1 for internal, 2 for external, or 3 for both), and the zone (0 to 3).</p> <p>External: Allows you to make announcements through your office's loudspeaker system (if connected).</p> <p>External/Internal: Allows you to make announcements through both your Norstar telephone speakers and your office's loudspeaker system. Enter the feature code, and the zone (0 to 3).</p> <p>Internal (Zone): Allows you to make announcements, through the Norstar telephone speakers, to a group of Norstar telephones. Enter the feature code, and the zone (0 to 3). 0 pages all zones.</p>
Service Modes	Feature 8 7	<p>Activates one of up to three different telephone answering options, eliminating the need to forward all your calls. Only an assigned Control Telephone can turn ON Service Modes. See your System Coordinator.</p> <p>Cancel Feature # 8 7</p>
Show Time	Feature 8 0 3	Briefly displays the date and the time.

Handling calls

Call Forward Sends your calls to another telephone in your **Norstar** system.
 Cancel

Camp-On: routes a call to another telephone even if all its lines are busy.

Call Information the name, number and line name of a ringing or held call. Press or **VIEW** repeatedly to cycle through the three displays of information.

Note: Names and numbers for external callers are displayed only if you have subscribed to Call Display services from your local telephone company.

Call Park Automatically puts a call on hold so that it can be retrieved from any telephone in your **Norstar** system. The display shows a retrieval code, 101 or 102.

or Call Park Retrieval: Answers a parked call from any telephone in your **Norstar** system by pressing and dialing the retrieval code. On the M7100 Telephone, dial just the retrieval code. The retrieval code is made up of a programmable Call Park prefix (0 to 9), followed by a call number (01 or 02).

Conference

Setting up a three person call:

1. Make or answer the first call:
2. Put the first call on hold.
3. Make or answer the second call.
4. Press (or press if programmed).
5. Press the line button of the first held call. (This step is not required on the M7100 Telephone.)
6. Press to end the conference.

Splitting a conference: To speak privately to one of the callers, or to drop one call and stay connected to another, or to hold both parties as separate calls, you must first split the conference.

1. Press the line button for one of the calls. The other call is put on hold. To re-establish the conference, press .

Removing yourself from the conference temporarily:

1. Press ; the other two callers can still speak to each other.

Removing yourself from the conference permanently:

1. Press (or if programmed). The other two parties remain connected.

Note: This type of transfer is supported only if one of the two remaining parties is internal.

170 / Compact DR5 Telephone Feature Card

Do Not Disturb	Feature <input type="text" value="8"/> <input type="text" value="5"/>	Blocks an alerting Priority Call on your telephone.
Exclusive Hold	Feature <input type="text" value="7"/> <input type="text" value="9"/> or Feature <input type="text" value="Hold"/>	Temporarily suspends an external call and prevents other telephones from picking it up. Exclusive Hold Retrieval: Press <input type="text" value="Line"/> of the held call. (Press <input type="text" value="Hold"/> on the M7100 Telephone.)
Group Listening	Feature <input type="text" value="8"/> <input type="text" value="0"/> <input type="text" value="0"/> <input type="text" value="2"/>	Use both the receiver and your speaker at the same time while you are on a call. Use the Mute feature on the <input type="text" value="Handsfree"/> button to disable the telephone microphone. If you experience feedback, turn the volume down, and before hanging up, press <input type="text" value="Rls"/> . Cancel <input type="text" value="Feature"/> <input type="text" value="#"/> <input type="text" value="8"/> <input type="text" value="0"/> <input type="text" value="2"/>
Logit	Feature <input type="text" value="8"/> <input type="text" value="0"/> <input type="text" value="0"/> <input type="text" value="0"/>	Information for the current active call in your Call Log. Note: Names and numbers for external callers are displayed only if you have subscribed to Call Display services from your local telephone company.
Privacy	Feature <input type="text" value="8"/> <input type="text" value="3"/>	When Privacy is ON, other Norstar users with the same line are prevented from joining your current external call. If Privacy is OFF, other Norstar users with the same line can join in on your external call by pressing that line button. Enter the feature code a second time to restore the original setting.
Transfer	Feature <input type="text" value="7"/> <input type="text" value="0"/>	Sends a call to another telephone in your Norstar system. <i>Using Transfer</i> 1. Make or answer a call. 2. Press <input type="text" value="Feature"/> <input type="text" value="7"/> <input type="text" value="0"/> (or <input type="text" value="Transfer"/> if programmed). 3. Dial an internal telephone number. 4. If you wish, you can announce the call after the called party answers. 5. Press <input type="text" value="Rls"/> or JOIN. The call is immediately transferred. Note: If an external call is transferred to a busy internal line, or not answered after a few rings, the call automatically rings you back and the display indicates that the line was busy or that no one answered.

Answering and making calls

Call Pickup	(Feature) 7 6 Feature 7 5	Directed Pickup: Answers a selected telephone in your system. Group Pickup: Answers a call that is ringing at another telephone in the same pickup group. The external call that has been ringing longest is answered first.
	Feature 8 0 0	Trunk Answer: Answers an external call that is ringing on a line that has been placed into Service Modes from any telephone in the Norstar system. This feature does not work on private lines.
Call Queuing	Feature 8 0 1	Answers a call when several calls arrive at the same time. The external call that has been ringing longest is answered first.
Last Number Redial	Feature 5	Automatically redials the last external telephone number that you dialed. This feature is available on the Last No. memory button on most telephones.
Line Pools	Feature 6 4	Telephones can share several external lines for making outgoing calls without requiring each telephone to have a button for every line.
<p><i>Using a Line Pool:</i></p> <ol style="list-style-type: none"> 1. Press Intercom and dial the Line Pool access code for one of the Line Pools assigned to your telephone, or press Line pool (if programmed). 2. If you are using a line pool which connects you to the public network, dial the telephone number of the person you want to call. <p>If you are using a line pool which automatically connects you to a system other than Norstar, follow the procedure for using that system. Ask your System Coordinator if you need help.</p>		
<p>Note: See your System Coordinator for your Line Pool access code.</p>		
Priority Call	Feature 6 9	Interrupts a call at another telephone, or overrides Do Not Disturb at a telephone. See your System Coordinator.
Ring Again	Feature 2	When another telephone or Line Pool within the Norstar system is busy, Ring Again signals you to call back when the telephone or Line Pool becomes available. Cancel Feature # Q
Saved Number Redial	Feature 6 Q	When you are active on a call, this feature stores the external telephone number of a call you have dialed. When you are not active on a call, this feature redials the number previously stored.
Speed Dial	Feature 0	Dials the number stored for a Speed Dial code. After entering the feature code, enter the two-digit Speed Dial code (01 to 94) for the number you want.
Voice Call	Feature 6 6	Begin a conversation through the speaker of another telephone without first making the other telephone ring. To answer a Voice Call, pick up the receiver, or press Handsfree .

The Norstar Prime Telephone

What is a Prime Telephone?

A Prime Telephone can be any Meridian **Norstar*** telephone that has been assigned to provide a backup answering service for incoming external calls. An external call rings at a Prime Telephone when the call is not answered at any other **Norstar** telephones with that call's line appearance,

A Prime Telephone can be any one of the following:

- | any **Norstar** telephone
- | an M7310 telephone with a Busy Lamp Field (BLF)
- | an M7324 telephone with Central Answering Position (CAP) modules.

Your role in operating a Prime Telephone

As the assigned Prime Telephone operator, you are responsible for answering unanswered external calls. You are alerted to these calls when your telephone display shows you a descriptive message, the line indicator ► flashes, and the call rings.

After answering a call, you may take a message or redirect the call to another telephone.

Who assigns the external lines for my Prime Telephone?

Check with your System Coordinator to determine which external lines have been assigned for backup answering and which of those lines ring at your Prime Telephone. To help you do your job well, your Coordinator should provide a list of names and numbers associated with each internal telephone and external line, and a list of System Speed Dial names and numbers. Your Coordinator can also tell you which features have been assigned to your telephone.

* Meridian and **Norstar** are trademarks of Northern Telecom.

Answering calls

When do I answer a call?

You answer a call if:

- someone within the system calls you. You hear the **Norstar** internal ring (two quick rings followed by a longer pause), and an indicator ► flashes beside one of your telephone's Intercom buttons.
- an external call comes directly to your Prime Telephone. You hear the external ring, and an indicator ► flashes beside one of your telephone's external line buttons.
- a call is redirected to your Prime Telephone from somewhere else within the system. You hear an internal ring, an external ring, or the Camp-On tone (two quick beeps), and you see a message on the display of your telephone.

Note: You do not answer the call if your Prime Telephone does not ring.

How do I answer a call?

If you want a line to be automatically selected:

1. Pick up the receiver or press **Handsfree** (if assigned).

OR

If you want to manually answer a line:

1. Press the line button with a slow flashing indicator ►.
2. Pick up the receiver if you want the Handsfree microphone OFF.

Note: A fast flashing indicator ► shows that a line is on hold.

Handling more than one call at once

When you have more than one call arriving at your telephone, the Call Queuing feature allows you to answer each of the waiting calls by automatically selecting the next call for you.

Use Call Queuing when you are on a call and a new call alerts you by ringing at your telephone, or by sending Call Queuing tones.

1. Pick up the receiver to answer the first call.
2. Press **Feature** **8** **0** **1** or the Call Queuing button if programmed.
The call you were on is automatically put on hold and the new call is answered.
3. To return to a previous call:
Press the external line button of the call on hold.
4. Continue to answer incoming calls.
5. Press **Rls** when you are finished with the call you are on,

Redirected calls

Redirecting calls using display messages

The display messages which appear on your Prime Telephone for redirected internal calls should help you to understand why those calls were passed to your Prime Telephone. This information is useful when you need to decide what to do with the call once it has been answered.

The following table lists some example display messages that could appear on a Prime Telephone when you receive redirected calls:

Example Prime Telephone display message	What is happening to the call at the other telephone
Held by KAREN	Karen holds a call for too long.
JOHN DND	The call you transferred is returned to you because the telephone is in Do Not Disturb mode.
DRT Line02	Delayed Ring Transfer redirects an unanswered call on line 02.
Line01 to prime	A call on line 01 cannot ring elsewhere.
Line03>JANET	A call on line 03 was forwarded or routed to Janet, but was not answered.
Line04 call back	A transferred, camped, or parked call on line 04 was returned to the originator using the Callback feature, but was not answered.

The Held Line Reminder message **Held call** is repeated periodically after the first message **Held by KAREN** appears. This message is accompanied by the same tone used with the Camp-On feature (two quick beeps).

Completing a call

Your options

You have just answered a call for someone else. What do you do next?

You can:

Transfer the call to another telephone within or outside of the **Norstar** system.

O R

Camp the call on another **Norstar** telephone.

OR

Park the call and page someone to pick it up.

OR

Take a message.

Transferring the active call

To another **Norstar** telephone:

1. Check whether the telephone to which you want to transfer is already busy:

- Is there an indicator ► beside the Internal Autodial button for the other telephone?
- If you have a BLF, is the indicator ON for the other telephone?

2. Transfer the call using one of these four methods:

*Transfer with Announcement - you first talk on the telephone to the person to whom you want to transfer the call.

*Transfer without Announcement - you immediately transfer the call after talking to the caller.

- Establish a conference call.
- Transfer using hold.

Do not forget that you can use programmed **Autodial** buttons on your **Norstar** telephone and CAP module (if installed) to select a **Norstar** telephone.

To a telephone outside the **Norstar** system:

1. Call the person to whom you wish to transfer the call.
2. Establish a conference with the two parties.
3. Drop out of the conference using .

Note: At least one of the remaining parties must be internal.

Completing a call

Camping the call

If the **Norstar** telephone you want to transfer the call to is busy on another call, you may want to camp the call on that telephone. The person receiving the camped call will hear Camp-On tones (two quick beeps).

1. Press **Feature** **8** **2** or the Camp-On button (if programmed).
2. Dial the Extension number of the other telephone or press its Internal **Autodial** button if programmed.

Announcing the active call

You are trying to pass calls you have answered to co-workers who are not at their telephones. Using the Page feature, you can announce the calls over the **Norstar** telephones, an external loudspeaker, or both. A co-worker hearing an announcement can answer the call from the nearest **Norstar** telephone.

If you want your co-worker to take the call from a specific Norstar telephone:

1. Place the call on hold.
2. Using the Page feature, announce the call and the location of the telephone to which you will transfer the call.
3. Transfer the call to the appropriate **Norstar** telephone.

OR

Camp the call on the appropriate **Norstar** telephone.

4. Replace your receiver.

If you want your co-worker to take the call on a specific line:

1. Place the call on hold.
2. Use the Page feature to announce the call and its line number.
3. Replace the receiver.

Your co-worker can now go to the nearest **Norstar** telephone that has that line, select the line, and lift the receiver.

If you want your co-worker to take the call from any Norstar telephone:

1. Use the Call Park feature to place the call on hold. Your telephone shows a three-digit Call Park Retrieval code on the display.
2. Use the Page feature to announce the call and the Call Park Retrieval code.
3. Replace your receiver.

Your co-worker can now retrieve the call from any other **Norstar** telephone by lifting the receiver and dialing the three-digit code.

Note: Remember that callback (the call is redirected back to your Prime Telephone) occurs if your transferred, parked, or camped call goes unanswered.

Useful Norstar features

Informing your co-workers about their calls

Use the Send Message feature to notify co-workers that they should call you for information.

If the person you are trying to call is on another line, or their telephone has Do Not Disturb ON, a display message shows you that their telephone is busy. If the person you are trying to call does not answer, a display message informs you that there is no reply. In each case, you can use the Ring Again feature.

The Ring Again feature is a method of ensuring that you immediately know when there is a change in the use of the other telephone. You can then try again to place a call.

Working with other features

Some of the many special features which **Norstar** provides may be particularly useful to you. Some of these features, however, are only available if assigned during Configuration or Administration programming. Speak to your System Coordinator to determine which features you can use, and to obtain details on how to use them.

Answer Group: You can immediately answer and monitor a specific group of **Norstar** telephones, for example, your managers', using Answer buttons.

Automatic Handsfree: If programmed, you can use the Handsfree microphone and speaker for all your calls.

Call Pickup Directed: Anyone in the office can answer a call ringing at any other **Norstar** telephone by dialing that telephone's Extension number.

Call Pickup Group: Any member of a specified group can answer an external or internal call ringing at another telephone within that specified group.

Direct-Dial Telephone: If your Prime Telephone is administered as a **Direct-Dial** telephone, anyone assigned to your Direct Dial telephone can quickly contact you by dialing an assigned single-digit number.

Hotline: A **Norstar** telephone may be programmed to automatically dial your Prime Telephone as soon as its receiver has been lifted.

Page Zone: If you do not want to disturb the entire office with an announcement, you can direct the page to a choice of smaller areas.

Priority Call: If you have answered an urgent call for someone who is busy on another line, you can interrupt the person with this feature.

Other information

Some unique situations

If an external call comes to you, and you do not have a button representing the line the call is on, the indicator ► for that call will appear next to any available Intercom button on your telephone.

If your Prime Telephone receives a callback call, you will hear the **Norstar** ring instead of the External ring.

The Held Line Reminder or the Delayed Ring Transfer feature is not available unless assigned during Configuration programming.

If you are using all of your external line buttons and Intercom buttons, you can still receive a camped call (you will hear two quick beeps).

If your Prime Telephone is an M7324 telephone, you can monitor the busy/not busy status of other **Norstar** telephones. Check for the presence or absence of indicators ► beside the Internal **Autodial** buttons for the other telephones.

Where to get help

To learn more about **Norstar** and its features, the System Coordinator can provide you with the following **Norstar** documents:

*The **Norstar** Telephone User Cards* show you how to:

- make a external call
- make an internal call
- put a call on hold
- use **Handsfree**
- program memory buttons.

The ***Norstar** Feature Card* lists the feature codes and describes the features.

The ***Norstar** Busy Lamp Field (BLF) User Card* describes how to use the Busy Lamp Field.

The ***Norstar** Central Answering Position (CAP) User Card* describes how to use Central Answering Position modules.

Your Norstar M7100 telephone

Release button
cancels active calls.

Display
shows the time, date, call information and guides you while using **Norstar*** features.

Memory button
is programmable to store a feature or to automatically dial internal or external number.

Dial pad

Feature button
starts or ends a feature.

Volume control

Hold button

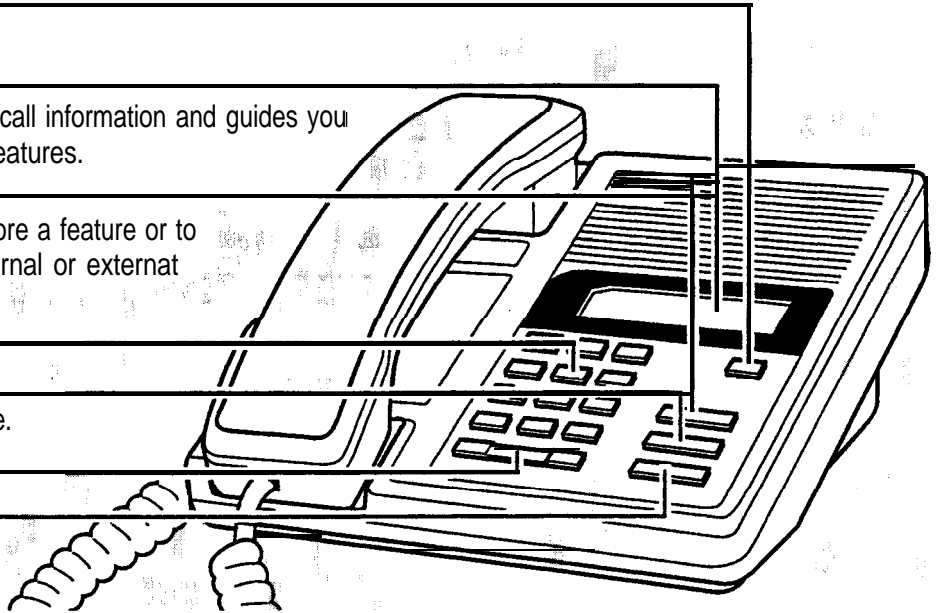

Button inquiry

Confirm that your memory button has the correct snap-on cap by checking its programming.

1. Release all calls and open lines with dial tone.
2. Press **Feature** ***** **0**.
3. Read the display.
4. Press **Feature** when finished.

Adjusting display contrast

1. Press **Feature** ***** **7**.
2. Press **1** to **9** for the level you want.

Selecting a ring type and volume

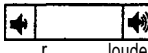
1. Press **Feature** ***** **6**.
2. Press **1**, **2**, **3** or **4** to hear the different types of rings.
3. While the telephone is ringing, press  to adjust the volume.
4. Press **Feature** **0** to store the ring.

Adjusting receiver or telephone speaker volume

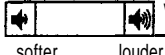
1. Press  when using the receiver or the speaker.

* Meridian and **Norstar** are trademarks of Northern Telecom.

Making calls

Internal calls

1. Pick up the receiver.
 2. Dial the internal number.
-

External calls

1. Pick up the receiver.
 2. Dial **9** (or your system's external line access code).
 3. Dial the external telephone number.
-

Note: Internal numbers and the external access code are supplied by your System Coordinator.

Making and answering a second call

The M7100 telephone allows you to have two calls active at the same time. By using **Hold** you can switch between calls.

To answer a second call while on another call

1. Press **Hold** to put the first call on hold.
The second **call** automatically comes onto the line.

To hold a call and make a second call

1. Press **Hold** to put the first call on hold.
2. Dial the telephone number for the second call.

*To return to the first **call***

1. Press **Hold** again to return to the first call on hold.
The second call is automatically put on hold.
-

Hold

To hold a call

1. Press **[Hold]**.
2. Press **Hold** again to return to the call on hold.
Check the display for confirmation or additional information.

Programming the memory button

About the memory button

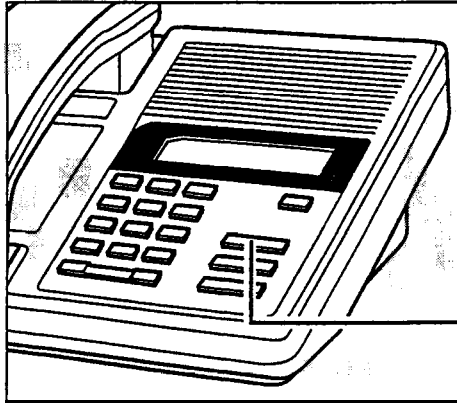

The memory button can store a telephone number or feature code to give you one touch dialing or feature activation. You can change the memory button by programming it with a new number or feature code.

Memory button

Remember: Press * to check the memory button.

Programming memory buttons

External autodial

1. If you are on a call or an open line with dial tone, press or .
2. Press * .
3. Dial the external number.
4. Press to store the number.
5. Label your new button.

Internal autodial

1. If you are on a call or an open line with dial tone, press or .
2. Press * .
3. Dial the internal number.
4. Label your new button.

Features

1. If you are on a call or an open line with dial tone, press or .
2. Press * .
3. Press and the feature code.
4. Label your new button.

Erasing memory buttons

1. If you are on a call or an open line with dial tone, press or .
2. Press * .
3. Press to erase the button.

Your Norstar M7208 telephone

Display _____
shows the time, date, call information and guides you while using **Norstar*** features.

Indicators _____
appear beside active lines and features.

Feature button _____
starts or ends a feature.

Release button _____
cancels active calls.

Hold button _____

Dial pad _____

Volume control _____

Memory and line buttons _____
are buttons with indicators for one touch dialing, feature operation or line access.

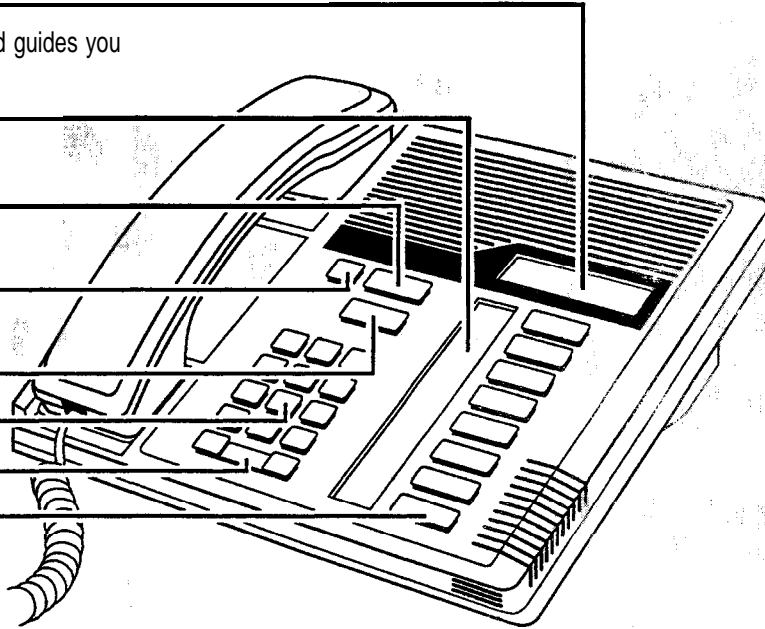

Button Inquiry

Confirm that your memory and line buttons have the correct snap-on caps by checking their programming.

1. Release all calls and open lines with dial tone.
2. Press **Feature** * 0 .
3. Press the button you want to check.
4. Read the display.
5. Press **Feature** when finished.

Adjusting display contrast

1. Press **Feature** * 7 .
2. Press a number on the dial pad for the contrast level you want, the higher the number the higher the contrast level.

Selecting a Ring Type and volume level

1. Press **Feature** * 6 .
2. Press **1**, **2**, **3** or **Q** to hear the different types of rings.
3. While the telephone is ringing, press **softer** **louder** to adjust the volume.
4. Press **softer** to store the ring.

Adjusting receiver or telephone speaker volume

1. Press **softer** **louder** when using the receiver or the speaker.

* Meridian and **Norstar** are trademarks of Northern Telecom.

Making calls

About line buttons

Norstar systems can have different types of line buttons. Match the line buttons on your telephone with the ones below for instructions on how to use them.

Intercom

[L i n e]

Internal calls using Intercom buttons

1. Pick up the receiver.
2. If ► appears beside an Intercom button, then dial.
OR
Press an Intercom button without ►, then dial.

External calls using numbered Line buttons

1. Pick up the receiver.
2. When ► appears beside a numbered Line button, then dial.
OR
Press a numbered Line button without ►, then dial.

Note: Internal numbers are supplied by your System Coordinator.

4321

Internal calls using extension buttons

1. Pick up the receiver.
2. When ► appears beside an extension button, then dial.

External calls using extension buttons

1. Pick up the receiver.
2. When ► appears beside the extension button, dial **9** (or your system's external line access code) and the number.

Hold

Holding Calls

1. Press **Hold**. The ► flashes beside the line on hold.
2. Press the line button with the flashing ► to return to the call.
Check the display for confirmation or additional information.

Automatic hold

Calls are put on hold automatically when you switch from one line to another.

Handsfree

This button operates the telephone's built-in microphone and speaker in place of the receiver. Your System Coordinator can program Handsfree to your telephone.

Making calls

1. Press **Handsfree** instead of picking up the receiver.

Switching between Handsfree and handset

1. Press **Handsfree** and replace the handset to switch to Handsfree.
2. Pick up the receiver to switch back.

Using Mute

1. Press **Handsfree** to turn the microphone OFF.
2. Press **Handsfree** again to turn the microphone ON.

Dialing without lifting the handset

1. Press a line button without ►, then dial your call.
2. When answered, pick up the receiver, or press **Handsfree**.
3. If the call is not answered, or the line is busy, press **Ris**.

Programming memory buttons

About memory buttons

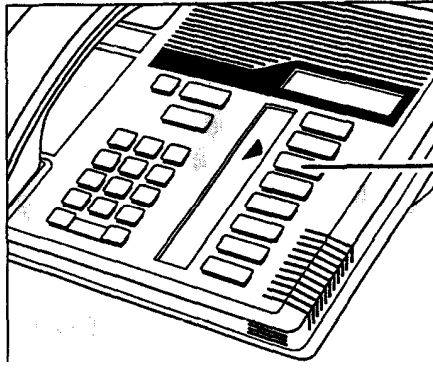

Memory buttons are the buttons with indicators other than line or Handsfree buttons. Memory buttons store telephone numbers or feature codes to give you one touch dialing or feature activation. You can change what a memory button does by just programming it with a new number or feature. You cannot program a line or Handsfree button.

Remember: Press **Feature** ***** **0** to check a memory or line button,

Programming memory buttons

External *autodial*

1. If you are on a call or an open line with dial tone, press **Hold** or **Rls**.
2. Press **Feature** ***** **1**.
3. Press a memory button.
4. Dial the external number.
5. Press **Hold** to store the number.
6. Label your new button.

Internal *autodial*

1. If you are on a call or an open line with dial tone, press **Hold** or **Rls**.
2. Press **Feature** ***** **2**.
3. Press a memory button.
4. Dial the internal number.
5. Label your new button.

Features

1. If you are on a call or an open line with dial tone, press **Hold** or **Rls**.
2. Press **Feature** ***** **3**.
3. Press a memory button.
4. Press **Feature** and the feature code.
5. Label your new button.

Erasing memory *buttons*

1. If you are on a call or an open line with dial tone, press **Hold** or **Rls**.
2. Press **Feature** ***** **1**.
3. Press the memory button you want to erase.
4. Press **Hold** to erase the button.

Your Norstar M7310 telephone

Shift button

for using the top function of a dual-memory button,

Display

shows the time, date, call information and guides you while using Norstar* features. The lower line of the display is reserved for display button instructions.

Dual-memory buttons

store any two features and/or autodial numbers,,

Display buttons

Feature button starts or cancels a feature.

Release button cancels active calls.

Hold button

Dial pad

Memory and line buttons are buttons with indicators for one touch dialing, feature operation or line access.

Volume control

Indicators

appear beside active lines and features.

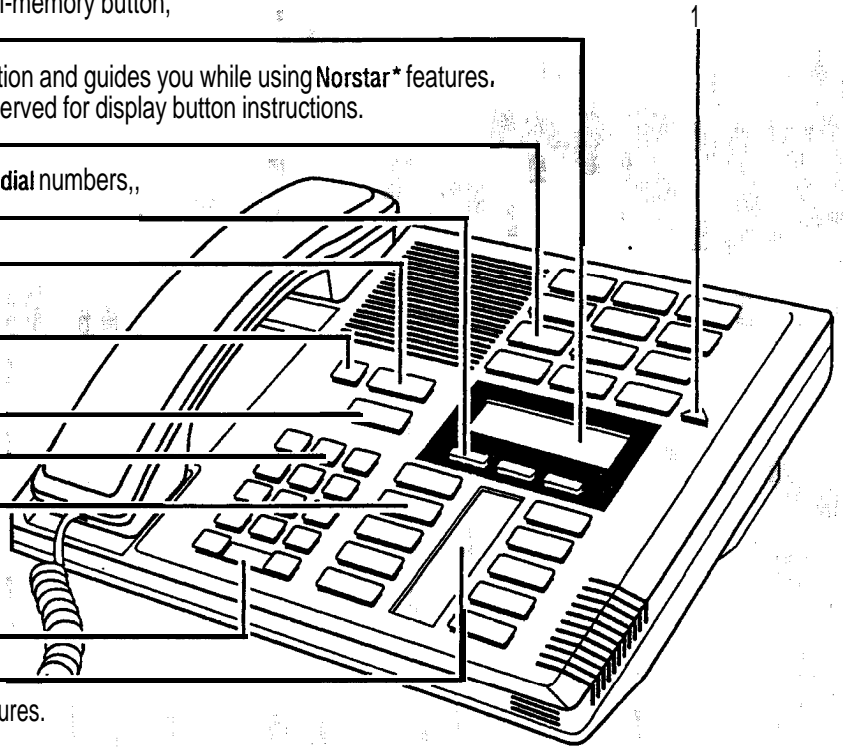

Using display buttons

Display buttons change with each feature you use. The labels for display buttons appear in capital letters directly above them on the second line of the display. A display button with an "OK" label above it is represented as OK in this card.



Button inquiry

Confirm that your memory and line buttons have the correct snap-on caps by checking their programming.

1. Release all calls or open lines with dial tone.
2. Press **Feature** * 0 .
3. Press the button(s) you want to check and read the display.
4. Press **Feature** when finished.

Adjusting display contrast

1. Press **Feature** * 7 .
2. Press UP or DOWN for the level you want.
3. Press OK when finished.

Selecting a ring type and volume level

1. Press **Feature** * 6 .
2. Press 1 , 2 , 3 or 4 to hear the different types of rings.
3. While the telephone is ringing, press  to adjust the volume.
4. Press OK to store the ring.

softer louder

* Meridian and Norstar are trademarks of Northern Telecom.

About line buttons

Nor-star systems can have different types of line buttons. Match the line buttons on your telephone with the ones below for instructions on how to use them.

Intercom

Line 1

Internal calls using Intercom buttons

1. Pick up the receiver.
2. If ► appears beside an Intercom, button, then dial.
OR
Press an Intercom button without ►, then dial.

External calls using numbered Line buttons

1. Pick up the receiver.
2. When ► appears beside a numbered Line button, then dial.
OR
Press a numbered Line button without ►, then dial.

Note: Internal numbers are supplied by your System Coordinator.

4321

Internal calls using extension buttons

1. Pick up the receiver.
2. When ► appears beside an extension button, then dial.

External calls using extension buttons

1. Pick up the receiver.
2. When ► appears beside the extension button, then dial **Q** (or your system's external line access code) and the number.

Hold

Holding Calls

1. Press **Hold**. The ► flashes beside the line on hold.
2. Press the line button with the flashing ► to return to the call.
Check the display for confirmation or additional information.

Automatic hold

Calls are put on hold automatically when you switch from one line to another.

Handsfree

This button operates the telephone's built-in microphone and speaker in place of the receiver. Your System Coordinator can program Handsfree to your telephone.

Making calls

1. Press **Handsfree** instead of picking up the receiver.

Switching between Handsfree and handset

1. Press **Handsfree** and replace the handset to switch to Handsfree.
2. Pick up the receiver to switch back.

Using Mute

1. Press **Handsfree** to turn the microphone OFF.
2. Press **Handsfree** again to turn the microphone ON.

Dialing without lifting the handset

1. Press line button without ►, then dial your call.
2. When answered, pick up the receiver, or press **Handsfree**.
3. If the call is not answered, or the line is busy, press **Ris**.

Programming memory buttons

About memory buttons

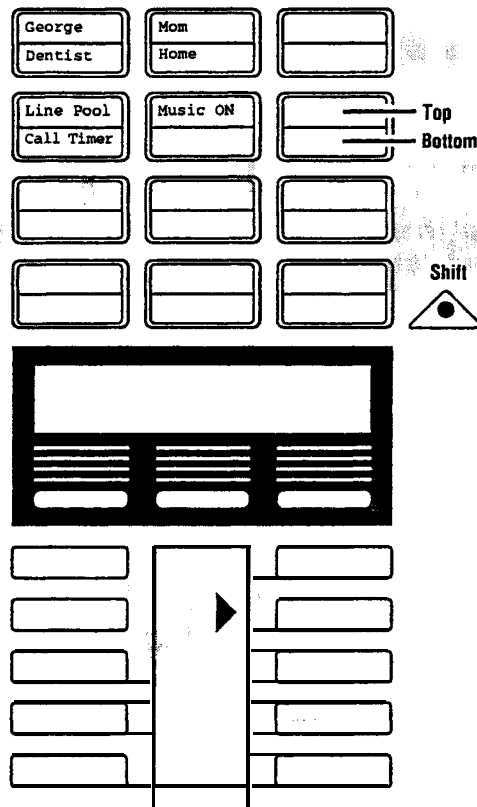

There are two types of memory buttons: single-memory and dual-memory. Memory buttons store telephone numbers or feature codes to give you one touch dialing or feature activation.

Dual-memory buttons

To use the bottom function, press the dual-memory button.

To use the top function, press the shift button, then press the dual-memory button.

Single-memory buttons

Single-memory buttons are the buttons with indicators other than line or Handsfree buttons.

Remember.- Press **Feature** * **0** to check a memory or line button.

Programming memory buttons

External autodial

1. If you are on a call or an open line with dial tone, press **Hold** or **Rls**.
2. Press **Feature** * **1**.
3. Press a memory button.
4. Dial the external number.
5. Press **OK** to store the number.
6. Label your new button.

Internal autodial

1. If you are on a call or an open line with dial tone, press **Hold** or **Rls**.
2. Press **Feature** * **2**.
3. Press a memory button.
4. Dial the internal number.
5. Label your new button.

Features

1. If you are on a call or an open line with dial tone, press **Hold** or **Rls**.
2. Press **Feature** * **3**.
3. Press a memory button.
4. Press **Feature** and the feature code.
5. Label your new button.

Erasing memory buttons

1. If you are on a call or an open line with dial tone, press **Hold** or **Rls**.
2. Press **Feature** * **1**.
3. Press the memory button you want to erase.
4. Press **OK** to erase the button.

Your Norstar M7324 telephone

Memory and line buttons are buttons with indicators for one touch dialing, feature operation or line access.

Display shows the time, date, call information and guides you while using **Norstar*** features. The lower line of the display is reserved for display button instructions.

Display buttons

Dial pad

Volume control

Feature button starts or ends a feature.

Hold button

Release button cancels active calls.

Indicators

appear beside active lines and features.

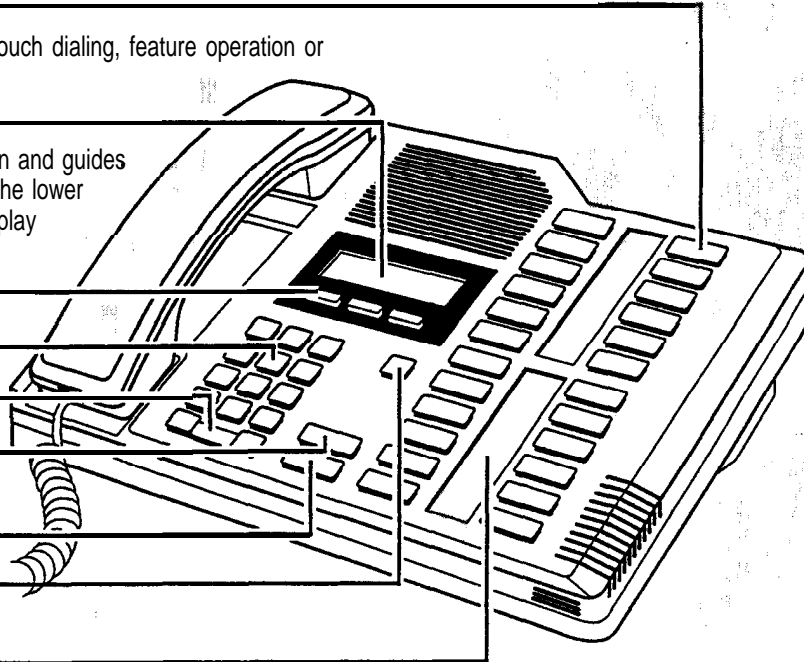

Using display buttons

Display buttons change with each feature you use. The labels for display buttons appear in capital letters directly above them on the second line of the display. A display button with an "OK" label above it is represented as OK in this card.

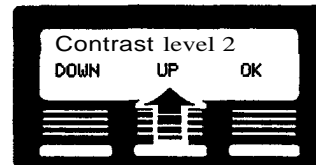

Button inquiry

Confirm that your memory and line buttons have the correct snap-on caps by checking their programming.

1. Release all calls or open lines with dial tone.
2. Press **Feature** * 0 .
3. Press the button(s) you want to check and read the display.
4. Press **Feature** when finished.

Adjusting display contrast

1. Press **Feature** * 7 .
2. Press UP or DOWN for the level you want.
3. Press OK when finished.

Selecting a ring type and volume level

1. Press **Feature** * 6 .
2. Press 1 , 2 , 3 or 4 to hear the different types of rings.
3. While the telephone is ringing, press to adjust the volume.
4. Press OK to store the ring.

* Meridian and **Norstar** are trademarks of Northern Telecom.

Making calls

About line buttons **Norstar** systems can have different types of line buttons. Match the line buttons on your telephone with the ones below for instructions on how to use them.

Intercom

Line 1

Internal calls using Intercom buttons

1. Pick up the receiver.
2. If ► appears beside an Intercom button, then dial.
OR
Press an Intercom button without ►, then dial.

External calls using numbered Line buttons

1. Pick up the receiver.
2. When ► appears beside a numbered Line button, then dial.
OR
Press a numbered Line button without ►, then dial.

Note: Internal numbers are supplied by your system coordinator.

4321

Internal calls using extension buttons

1. Pick up the receiver.
2. When ► appears beside an extension button, then dial.

External calls using extension buttons

1. Pick up the receiver.
2. When ► appears beside the extension button, then dial **9** (or your system's external line access code) and the number.

Hold

Holding Calls

1. Press **Hold** ► flashes beside the line on hold.
2. Press the line button with the flashing ► to return to the call.
Check the display for confirmation or additional information.

Automatic hold

Calls are put on hold automatically when you switch from one line to another.

Handsfree

This button operates the telephone's built-in microphone and speaker in place of the receiver. Your System Coordinator can program Handsfree to your telephone.

Making calls

1. Press **Handsfree** instead of picking up the receiver.

Switching between Handsfree and handset

1. Press **Handsfree** and replace the handset to switch to Handsfree.
2. Pick up the receiver to switch back.

Using Mute

1. Press **Handsfree** to turn the microphone OFF.
2. Press **Handsfree** again to turn the microphone ON.

Dialing without lifting the handset

1. Press a line button without ►, then dial your call.
2. When answered, pick up the receiver, or press **Handsfree**.
3. If the call is not answered, or the line is busy, press **Ris**.

Programming memory buttons

About memory buttons

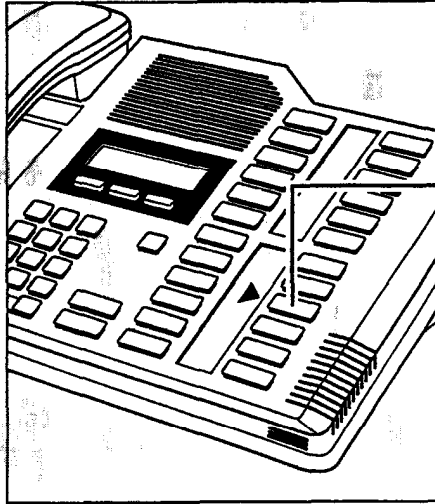

Memory buttons are the buttons with indicators other than line or Handsfree buttons. Memory buttons store telephone numbers or feature codes to give you one touch dialing or feature activation. You can change what a memory button does by just programming it with a new number or feature.

If you have programmed a memory button with an internal number the indicator comes on when the number is busy.

Remember: Press **Feature** ***** **0** to check a memory or line button.

Programming memory buttons

External *autodial*

1. If you are on a call or an open line with dial tone, press **Hold** or **Rls**.
2. Press **Feature** ***** **1**.
3. Press a memory button.
4. Dial the external number.
5. Press **OK** to store the number.
6. Label your new button.

Internal *autodial*

1. If you are on a call or an open line with dial tone, press **Hold** or **Rls**.
2. Press **Feature** ***** **2**.
3. Press a memory button.
4. Dial the internal number.
5. Label your new button.

Features

1. If you are on a call or an open line with dial tone, press **Hold** or **Rls**.
2. Press **Feature** ***** **3**.
3. Press a memory button.
4. Press **Feature** and the feature code.
5. Label your new button.

Erasing memory buttons

1. If you are on a call or an open line with dial tone, press **Hold** or **Rls**.
2. Press **Feature** ***** **1**.
3. Press the memory button you want to erase.
4. Press **OK** to erase the button.

Glossary

A

Access code: A sequence of characters used to gain entry into any type of **Norstar** system programming.

Administration: A program that lets one person in your office (the System Coordinator) assign and maintain certain settings on the **Norstar** system.

Administration access code: A code required to access Administration programming. You may be asked for an Administration password.

Administration password: A one- to six-digit password that prevents unauthorized access to Administration programming. The Administration password can be assigned and changed in Administration programming.

Analog Terminal Adapter (ATA): A device that permits the connection of analog telecommunication devices such as FAX machines, answering machines, and single line telephones to the **Norstar** system. Programmed defaults for the **ATA** are automatically assigned by the **Norstar** system.

Answer button: A telephone button with an indicator that is used to monitor another telephone. The Answer button indicates incoming calls destined for the other telephone. Someone working at a telephone with Answer buttons (a receptionist, for example) can receive all ringing and visual indication of incoming calls for other telephones, and answer those calls when necessary. One telephone can have up to four Answer buttons. An Answer button is automatically assigned to a telephone when that telephone is assigned an Answer DN.

Answer DN: A Directory Number (DN) of a telephone that is monitored by an Answer button. Up to four Answer DNs can be assigned to a telephone by the Customer Service representative.

Auto Bumping: A setting that determines what the system does with new Call Log items when your Call Log is full. When Auto Bumping is ON, a new log entry causes the oldest entry to be deleted. If Auto Bumping is OFF, your **Norstar** system does not log calls when your log is full.

Autodial button: A memory button that, if programmed, provides one-touch dialing of external or internal numbers.

Automatic Dial: A feature that allows you to dial without having to pick up the receiver or select a line. You must have a Prime line to use Automatic Dial.

Automatic Handsfree: A feature that automatically activates Handsfree operation when you make or answer a call. Automatic Handsfree is assigned in Administration programming.

Automatic Hold: A feature that automatically places an active call on hold when you select another line. Automatic Hold is programmed by your Customer Service representative.

Automatic Privacy: See Privacy.

Automatic Telephone Relocation: A feature that lets a telephone retain its personal and system programming when it is plugged into a different **Norstar** modular jack. Automatic telephone relocation is enabled by your Customer Service representative.

Auxiliary ringer: A separate external telephone ringer or bell that can be programmed to ring when a line or a telephone rings. An auxiliary ringer may be programmed to ring only when the system is in a particular service mode. Programming of an auxiliary ringer is done in Administration programming after the feature has been enabled by your Customer Service representative.

B

Background Music: A feature that lets you hear music from the speaker of your **Norstar** telephone. It is available only if a music source has been attached to the KSU and the feature has been enabled by your Customer Service representative.

Busy Lamp Field (BLF): A device with a liquid crystal display (LCD) panel of indicators that shows the status of up to 24 telephones in the **Norstar** system. The BLF shows a telephone as busy if it is active on a call, has Do Not Disturb turned ON, or is being used for programming. The BLF attaches to the M7310 Telephone.

Button caps: Interchangeable plastic caps that fit over the buttons of **Norstar** telephones. They are used to indicate the features programmed onto each programmable memory button. Button caps are either pre-printed or have clear windows that allow you to label the buttons.

Button Inquiry: A feature that allows you to check the function of each programmable button on your **Norstar** telephone.

Bypass Restrictions: A setting that allow@ you to override any Call Restrictions applied to specific System Speed Dial numbers. Bypass Restrictions can be turned on in **Administration** programming.

C

Call Forward: A feature that forwards all the calls arriving at your telephone to another telephone in your **Norstar** system.

Call Forward No Answer: A feature that forwards all calls arriving at your telephone to another designated telephone in your **Norstar** system after a specific number of rings. Call Forward No Answer is assigned in **Administration** programming.

Call Forward On Busy: A feature that forwards all calls at your telephone to another designated telephone if your telephone is busy. This feature is assigned in **Administration** programming.

Call Forward Override: A feature that allows you to call someone and ask them to stop forwarding their calls to you.

Call Information: A feature that allows you to display information about incoming calls. For external calls, you can display the caller's name, telephone number and the line name. For an internal call, you can display the name of the caller and their internal number. You can obtain information about ringing, answered, or held calls.

Call Log: A feature that accesses a record of incoming calls. The log could contain the following information for each call: sequence number in the Call Log, name and number of caller, long distance indication, indication if the call was answered, time and date of the call, number of repeated calls from the same source, and name of the line that the call came in on. See **Auto Bumping**, **Enter Call Log**, **Logit**, and **Logging Options** for further information.

Call Park: A feature that allows you to place a call on hold so that someone can retrieve it from any other telephone in the **Norstar** system by selecting an internal line and entering a retrieval code. The retrieval code appears on the display of your telephone when you park the call. You can park up to nine calls on the system at one time.

Call Park Callback: See **Callback**.

Call Park prefix: The first digit of the retrieval code of a parked call. This **digit** cannot conflict with the **first digit** of any existing **DNs**, Line Pool access codes, the Direct-dial digit, or the external line access code. The default Call Park prefix digit is "1". It may be set to none, in which case Call Park is disabled. Call Park prefix is assigned by your Customer Service representative.

Call Pickup Directed: A feature that lets you answer a call ringing at any **Norstar** telephone by entering the internal number of that telephone before taking the call. Call Pickup Directed is activated by your Customer Service representative.

Call Pickup Group: See Pickup Group.

Call Queuing: A feature that allows you to answer calls in order of priority if you have several calls waiting at your telephone. Priority is given to external incoming calls, followed by callback and camped calls.

Callback: A feature that returns parked, camped or transferred calls to your telephone if they are not answered at another telephone. How long the system will wait before Callback occurs is set by your Customer Service representative.

Camp-On: A feature that lets you re-route a call to a telephone even if all the lines on that telephone are busy. To answer a camped call, use Call Queuing or select a line if the camped call appears on your telephone. Priority is given to queued calls over camped calls.

Camp timeout: The length of a delay before a camped call is returned to the telephone that camped the call. This delay is set by your Customer Service representative.

Capabilities: A section heading in Administration programming, that covers the dialing filters, set abilities, and line abilities that can be assigned to **Norstar** lines, telephones, or Class of Service passwords.

Class of Service (COS): A set of **Norstar** features and lines available to the user for a call. The Class of Service for a call is determined by the Dialing Filters assigned to the telephone in Administration programming. The Class of Service for a call can be changed by entering a six-digit Class of Service password. Class of Service and Class of Service passwords are assigned in Administration programming.

Class of Service password: A six-digit code that lets you switch from your current Class of Service to one that lets you dial numbers prohibited by your current Class of Service.

Conference; A feature that allows you to establish a three-person call at your **Norstar** telephone.

Conference using privacy: A feature that allows you to turn privacy OFF for a call allowing another person with the same line to **press** the line button and join in your conversation, forming a conference. Normally your calls are private; no one else can pick up your line and join in.

Contrast Adjustment: A feature that allows you to set the contrast level of your telephone display;

Control telephone: A telephone that can place the lines for which it has responsibility in or out of a Service Mode. A telephone is programmed as a Control telephone and has lines assigned to it in Administration programming.

COS: See Class of Service.

Cursor: A short horizontal line that appears on the **Norstar** telephone display to indicate that characters can be entered using the dial pad.

D

Data Communications Interface: A **Norstar** device that lets you attach an RS-232 data device to your **Norstar** system.

Data terminal: A device, such as a modem; that can be used to transfer data instead of sound over a telephone network. You cannot use **Norstar** programming to set up such devices. See the documentation that accompanies the device.

Date: See Show Time or Time and Date.

DCI: See Data Communications Interface.

Defaults: The settings for all **Norstar** features when the system is first installed. Settings are changed from their defaults in Administration programming and by your Customer Service representative. In this manual, default settings are shown in bold text.

Delayed Ring Transfer (DRT) to Prime: A feature that transfers an unanswered call on an external line to the Prime Telephone associated with that line after a specified number of rings. This feature is activated by your Customer Service representative.

Dial mode: The dialing mode of a line can be either Tone or pulse. Pulse is traditionally used by rotary dial telephones. Tone is also referred to as dual-tone multi frequency (DTMF) tones. Dial mode can be programmed by your Customer Service representative.

Dialing filter: A feature that prevents certain telephone numbers from being dialed through a combination of restrictions and exceptions. Dialing filters can be applied to lines (line filters, to specific lines on a telephone (line/set filters), and to Class of Service passwords. The **Norstar Compact** system can handle up to 24 dialing filters.

Direct-dial: A feature that lets you dial a designated telephone in your **Norstar** system with a single digit. Direct-dial telephones are established in Administration programming. Telephones are assigned to a Direct-dial telephone in Administration programming.

Direct-dial number: A digit used system wide to call a Direct-dial telephone. The digit is programmed by your Customer Service representative.

Directed Pickup: See Call Pickup Directed.

Directory Number (DN): A unique number that is automatically assigned to each telephone or data terminal. The DN, also referred to as an internal number, is often used to identify a telephone when settings are assigned during programming.

Display: A liquid crystal display (LCD) on the **Norstar** telephone that guides you through feature operation and programming.

Display button: One of three buttons located directly beneath the display on M7310 and M7324 Telephones. During feature operation or programming, some or all of these buttons may be used to provide further options. If an option is available, it is shown in the bottom line of the two-line display, directly above the corresponding display button. Display buttons are represented in this manual as underlined capitals, e.g. OK.

Display digits: A sub-heading in Administration programming that allows you set whether an assigned name or the actual number is displayed when someone uses a system speed dial code.

DN: See Directory Number.

DRT delay: The number of rings before a Delayed Ring Transfer occurs. This is assigned by your Customer Service representative.

DRT to Prime: See Delayed Ring Transfer to Prime.

E

Emergency Telephone: A single-line telephone (also referred to as a **500/2500** telephone) that becomes active when there is no power to the Key Service Unit.

Exceptions: A component of a Dialing filter* Exceptions are numbers you can dial even if they are forbidden by a more general Restriction. See Restrictions.

External call: A call to a destination outside the **Norstar** system.

External code: The number you dial to get an external line. The default is 9, but this can be changed by your Customer Service representative. You do not always need an external code. It is primarily to support the **M7100** Telephone and single-line telephones using an Analog Terminal Adapter (ATA).

External line: A line on your **Norstar** telephone used for making calls to destinations outside the **Norstar** system.

External music source: See Music source.

External paging: A feature you can use to make voice announcements over an externally-mounted loudspeaker connected to the Key Service Unit. The external speaker is not a **Norstar** component and must be supplied by the customer.

Extra-dial telephone: A heading in Administration programming that allows you to assign an extra Direct-dial telephone when a service mode is active. You can have one Extra-dial telephone for each of the three service modes.

F

Feature button: A button that activates many **Norstar** features when it is pressed and followed by a Feature code. The Feature button is also used to exit a feature.

Feature Cartridge: A replaceable cartridge containing the **Norstar** features. The Feature Cartridge is inserted into the Key Service Unit.

Feature code: A number that is used to activate a particular feature.

Forward: See Call Forward.

Forward delay: The number of rings before an unanswered call is forwarded to another telephone when the Call Forward No Answer feature is ON. Forward delay is assigned in Administration programming.

Forward No Answer: See Call Forward No Answer.

Forward On Busy: See Call Forward On Busy.

Full Autohold (on idle line): A feature that, when activated, puts a line on hold when you select an available line and then do something that selects another line. Full Autohold is activated by your Customer Service representative.

Full Handsfree: See Handsfree.

G

Group Listening: A feature that allows you to have others in your office hear a caller through your phone's speaker. The caller hears you only when you speak into the receiver and cannot hear other people in the office.

H

Handsfree: A feature you can use to make calls without using the telephone receiver. Full Handsfree is activated in Administration programming. When it is activated, a **Handsfree/Mute** button is automatically assigned to the telephone.

Handsfree (HF) Answerback: A feature that automatically turns ON the microphone at a telephone receiving a Voice Call so that the person receiving the call can respond without lifting the receiver. Handsfree Answerback is activated in Administration programming.

Handsfree/Mute button: See Handsfree.

Headset: A head-mounted or ear-mounted telephone receiver that is used instead of the hand-held receiver. Headsets are not **Norstar** components and must be supplied by the customer.

Held (Line) Reminder: An indication that an external call has been placed on hold for a certain period of time. Your **Norstar** telephone rings and displays the message **Held call**. The **Held Line Reminder** feature and **Remind delay** are programmed by your Customer Service representative.

HF Answerback: See Handsfree Answerback.

Hold button: A button used to suspend calls so that the person using the telephone can perform another task without disconnecting the caller.

Hookswitch Flash: See Link time.

Host System Signaling: (Also referred to as End-to-End Signaling.) **Norstar** telephones can access a remote system or dial a number on an alternate carrier by means of Host feature activation, such as Link, Pause and Run/Stop.

Hotline: A feature that automatically calls a pre-assigned number when the telephone's receiver is lifted or the Handsfree/Mute button is pressed. A Hotline number can be an internal or external number. Hotline is programmed in Administration programming.

I/C: An abbreviation of Intercom button.

Installer: A person who installs the Norstar equipment, and performs System Startup and certain programming actions. The Installer or the System Coordinator can program Administration settings.

Intercom button: A button that provides access to internal lines used for calls within a **Norstar** system and access to external lines through a Line Pool or external code. A telephone may be assigned zero, one or two Intercom buttons. This is done by the Customer Service representative.

Intercom keys: See Intercom button.

Internal line: A line on your telephone dedicated to making calls to destinations inside your **Norstar** system. An internal line may still connect you with an external caller if you use it to access a line pool or to pick up a call using **Norstar** call handling features such as Call Park or Call Pickup Directed.

Internal number: A number (also referred to as a Directory Number or DN) that identifies a **Norstar** telephone or device.

Internal user: A person using a **Norstar** telephone within a **Norstar** system.

K

Key Service Unit (KSU): The central hardware component in the **Norstar** system. The KSU has its own processor and memory, and provides a physical point of connection for the various types of devices, telephones, and expansion modules used in **Norstar**. The KSU can function on its own as a basic system (with 24 **Norstar** telephones and 8 external lines), or with the addition of a Trunk Module (TM) that supports more external lines, or a Station Module (SM) that supports more **Norstar** telephones.

L

Line: The complete path of a voice or data connection between one telephone (or other device) and another.

Line abilities: The heading in Administration programming under which you assign Line Filters to lines.

Line filter: See Dialing filter.

Line names: The sub-heading in Administration programming that allows you to assign names to external lines.

Line number: A number that identifies an external line. The total number of lines depends on how many Trunk Modules are installed.

Line Pool: A group of lines used for making external calls. Line Pools provide an efficient way of giving a telephone access to external lines without taking up many line buttons. A line is assigned to be a member of a Line Pool by your Customer Service representative

Line Pool access code: A number that identifies a Line Pool. Line Pool access codes are assigned by your Customer Service representative.

Link time: A specific time delay that allows access to PBX features through a **Norstar** system. Link time is also referred to as a "Hookswitch Flash" or "Recall". Link time is assigned by your Customer Service representative.

Logging Options: A feature that allows you to select the type of calls that are stored in your Call Log. You can choose to log calls that were not answered by anyone within the system, to log calls that were unanswered at this telephone but answered elsewhere in the system, to log all calls answered and not answered at this telephone, or to not have calls automatically logged.

Logit: A feature that allows you to manually log call information when you are connected to a call.

M

M7100 Telephone: A telephone that has a one-line display and one programmable memory button without an indicator.

M7208 Telephone: A telephone that has a one-line display and eight programmable memory buttons with indicators.

M7310 Telephone: A telephone that has a two-line display, three display buttons, 10 programmable memory buttons with indicators, and 12 dual-memory programmable buttons without indicators. An M7310 Telephone can be equipped with a Busy Lamp Field.

M7324 Telephone: A telephone with a two-line display, three display buttons, and 24 programmable memory buttons with indicators. An M7324 Telephone can be equipped with a CAP module.

M7900 Telephone: A telephone with a touch-screen display that replaces the display and memory buttons of other **Norstar** telephones. It provides simplified access to **Norstar** Features and an interface to computer driven applications.

Memory buttons: The buttons that can be programmed to dial frequently used-features or numbers automatically. See M7100, M7208, M7310, M7324 and M7900 Telephone entries for their exact memory button configurations.

Message: A feature that allows you to indicate to another internal user that you would like them to call you.

Music source: A radio or other source of music that can be connected to the Key Service Unit to provide music for the Music on Hold and Background Music features. A music source is not part of the **Norstar** system and must be supplied by the customer.

N

Names: A feature that allows you to assign System Speed Dial numbers, external lines, telephones, and Service Modes in Administration programming. You can use up to sixteen characters to name a System Speed Dial number, and seven characters to name a telephone, line, or Service Mode. If a Name has not been assigned, the line number or DN appears on the display instead of a Name.

Night Service: See Service Modes.

Norstar Programming

Overlay: A paper template that is placed over the top four memory buttons with indicators on the M7310 or M7324 Telephone during programming. The overlay labels indicate the special function that each of the four buttons takes on during programming.

O

On hold: A setting that controls whether external callers hear music, periodic tones, or silence when they are placed on hold. This setting is programmed by your Customer Service representative.

Overlay: See **Norstar Programming Overlay**.

P

Page: A feature you can use to make announcements over the **Norstar** system. You can choose Internal Page (announce over the telephone speakers), External Page (announce over an externally-mounted, customer-supplied loudspeaker), or both Internal and External Page.

Page Zone: An area in the office that receives internal Page announcements independently of the rest of the office. Each Page Zone is identified by a number. Telephones are assigned to Page Zones in Administration programming.

Park prefix: See Call park prefix.

Park timeout: A delay before an unanswered parked call returns to the telephone that parked it. Park timeout is set by your Customer Service representative. See Call Park.

Password: A **specific sequence** of digits that you enter to gain access to **Norstar** programming or to override dialing restrictions. Passwords are also required for System Startup and Administration programming. See Class of Service password.

Pause: A system feature that allows you to set a **1.5-second** delay in a dialing sequence programmed on an external autodial.

Personal Speed Dial: A two-digit code (71-94) that can be programmed to dial external telephone numbers. Personal Speed Dial numbers are programmed for each telephone, and can be used only at the telephone on which they are programmed.

Pickup Group: A group of telephones. A telephone can be placed into one of four Call Pickup Groups. A call ringing at a telephone within a Pickup Group can be picked up at any other telephone within the same Pickup Group. A telephone is assigned to a Pickup Group in Administration programming.

Pool: See Line Pool.

Pre-dial: A feature that allows you to enter a number and check it on your telephone display before it is actually dialed. If the number is incorrect, you can edit it. The number is dialed only when you pick up the receiver or select a line.

Prime line: A line on your telephone that is automatically selected when you lift the receiver, press the **Handsfree/Mute** button or use *an* external dialing feature. A Prime line is assigned to a telephone by your Customer Service representative.

Prime telephone (Prime set): A telephone that provides backup answering for incoming calls on external lines. The Prime telephone for a line will ring for any unanswered calls on that line. A Prime telephone is assigned to a line by your Customer Service representative.

Priority Call: A feature you can use to make a Voice call to a telephone that is idle, busy or has Do Not Disturb activated. This feature is enabled for a telephone in Administration programming.

Privacy: A feature that determines whether a **Norstar** user may select a line in use at another telephone and join an established call. Privacy is set by your Customer Service representative, but can be turned ON and OFF by users during individual calls.

Private line: See Private to.

Private network: A telephone network consisting of owned or leased telephone lines used to connect different offices of an organization independently of the public network.

Private to: A line assigned to one telephone as a Private line by your Customer Service representative. The line cannot appear on any other telephone, except the Prime telephone for that line. Private lines cannot be placed into Line Pools,

Programming Overlay: See **Norstar** Programming Overlay.

Programming reminder: A chart on which you can record some commonly-used settings from Administration programming to keep the **Norstar** system's records up-to-date.

Programming: A series of procedures that set the way the **Norstar** system works. Programming includes system-wide settings and individual telephone and line settings.

Public line: An external line that can be assigned to any telephone and to many telephones. A line is assigned as Public by your Customer Service representative.

Public network: The regular telephone network that connects most homes and businesses.

R

Recall: See Link time.

Receiver: The handset of a telephone.

Remind delay: A feature that causes a telephone to beep and display the message

He1 d call when a call has been on hold for a programmable period of time. This period is the Remind delay, and is programmed by your Customer Service representative.

Restrictions: A component of a Dialing filter. Restrictions are numbers you cannot dial when that Dialing filter is in effect. See Exceptions.

Ringing Telephone (Ringing Set): A telephones that has been assigned to ring when a line has been placed into a Service Mode. Ringing Telephones are assigned in Administration programming.

Ringing: A programming function done by your Customer Service representative that assigns a line to ring or not ring at a telephone. If a line has been assigned as "No ring", an incoming call is shown only by a flashing indicator.

Rls button: A button that ends a call in the same way that hanging up the receiver does. It may also be used to end Startup, Administration programming and feature operations.

Run/Stop: A character that creates a breakpoint in a programmed external dialing sequence. When you press a programmed key, the system dials the number up to the Run/Stop. When you press it again, the system dials the digits following the Run/Stop.

s

SAPS: See Station Auxiliary Power Supply.

Service Modes: A feature that provides special ringing and telephone access after normal office hours, or when there are few people available to answer calls. Certain features become active when one or more lines are placed into a Service Mode. Service Modes settings are assigned in Administration programming.

Set: A telephone.

Set ability: A sub-heading in Administration programming under which set filters, line/set filters, and a variety of system features are assigned to individual telephones.

Set Copy: A programming section that allows you to copy programmable settings from one telephone to another-of the same type. Set Copy provides two options: duplicating System Data and User Data, or duplicating System Data only.

Set Copy does not Provide the same copy capability as the **COPY** display button, which is more selective of the settings that can be duplicated.

Set filter: See Dialing filter.

Set Names: A sub-heading in Administration programming that allows you to assign Names of up to seven characters to telephones.

Set Relocation: See Automatic Telephone Relocation.

Shift button: A small triangular button beside the dual-memory buttons on the upper half of the **M7310** Telephone. Press the shift button to store or access features on the top half of the dual-memory buttons.

Show Time: A feature that allows you see the current date and time on the **Norstar** telephone display while you are on a call.

Station: An individual telephone or other **Norstar** device.

Station Auxiliary Power Supply (SAPS): A device which provides power to a **Norstar** telephone that is connected more than 305 m (1000 ft) and less than 760 m (2500 ft) from the Key Service Unit, or to a CAP module,

System Coordinator: A person responsible for customizing the **Norstar** system through Administration programming and for helping co-workers use the **Norstar** system.

System Data: An option in the Set Copy function. System Data refers to the system settings that apply to all telephones and lines. System Data consists of the programmable settings from System Startup and Administration programming. It also includes the setting programmed by your Customer Service representative.

System Speed Dial Code: A two-digit code (01 to 70) that can be programmed to dial a telephone number up to 24 digits long. System Speed Dial codes are programmed for the entire **Norstar** system in Administration programming.

System Speed Dial Name: A sub-heading in Administration programming under which you can assign a name to a System Speed Dial Number.

System Speed Dial: A heading in Administration programming under which you can assign up to 70 numbers as System Speed Dial numbers.

System Startup: A procedure that initializes the system programming to defaults. When a **Norstar** system is first installed and powered up, System Startup must be performed before any programming can be done.

T

TCM line (Time Compression Multiplexing line): A two-wire digital station loop joining the cross-connect at the Key Service Unit to a telephone.

Telephone lock (Set lock): A feature that allows you to limit the number of features that may be used or programmed at a telephone. Full telephone lock allows very few changes or features, Partial telephone lock allows some changes and features, and No telephone lock allows any change to be made and any feature to be used. Telephone lock is assigned in Administration programming.

Time and Date: A display description. The current Time and Date appear on the display of idle **Norstar** telephones. The Time and Date can be changed in Administration programming.

Transfer: A feature that lets you redirect a call to another telephone. There are four types of Transfer; Transfer using Hold, Transfer with Announcement, Transfer without Announcement, and transfer using Unsupervised Conference.

Transfer Callback: A feature that returns a transferred call if it is not answered after a specific number of rings. The number of rings is programmed by your Customer Service representative. Transfer Callback does not apply to calls transferred externally.

Trunk: A physical connection between the **Norstar** system and the outside world using either the public telephone system or a private network.

Trunk Answer: A feature you can use to answer a call on any line that has an active Service Mode, even if that line does not appear on your telephone. Trunk Answer is activated in Administration programming,

U

User Filter: See Dialing filter.

V

Voice Call: A feature you can use to make an announcement or begin a conversation through the speaker of another telephone in the **Norstar** system. The telephone you call does not ring. Instead, the person you call hears a beep and then your voice. Their telephone beeps periodically to remind them that their microphone is open.

Index

A

Access Code
 External line 112

Access denied
 Conference 102
 Speed dial 151
 Accidental Disconnect
 Protection 153

Administration
 Dialing filters 36
 Direct Dial 35
 entering 17
 exiting 1%
 headings 16
 moving through 19
 Names 29
 overview 16
 Programming reminders 5%
 Service Modes 4%

Administration programming 1

Alarm telephone
 description 147

AI ready joined
 Dialing 114

AI ready Parked
 Call Park 92

Answer buttons 95, 137

Answerback 42

Autobumping
 feature description 84

Autodial 13%
 Buttons 13%
 feature description 74
 Host System Signaling 76
 losing data after power
 failure 75

Autodial full
 Autodial 74
 Speed dial 151

Automatic Call Information 54

Automatic Handsfree 105
 programming 42

Automatic telephone relocation
 153

Auxiliary Ringer
 programming 43
 Service Modes 51

B

Background Music 153

Button
 Indicators 69
 Release 13%
 Volume 13%

Button erased
 Autodial 75

Button Inquiry
 feature description 11%

Buttons
 Answer 137
 Autodial 13%
 Erasing programming 11%
 Feature 137, 13%
 Hold 137
 Line 13%
 Memory 137
 Programmed 13%

C

Call Display Information 3, 67

Call Display services 3

Call forward
 feature description 77

- No Answer 44
 - On Busy 43
 - Override 77
- Call Forward No Answer 77
- Call Forward on Busy 77
- Call Identification 53, 54, 55
- Call Information
 - display before or after answering 80
 - display for a call on hold 80
 - feature description 80
- Call Log 6
 - call from 85
 - add digits to a number 86
 - trim a number 86
 - choose logging options 82
 - entering 84
 - erase log items 85
 - feature description 82
 - navigating within 84
 - optional password 86
- Call Park 68
 - feature description 92
- Call Pickup 68
 - Assigning groups 96
 - feature description 94
 - priority of alerting calls 95
- Call Pickup (group)
 - programming 42
- Call Queuing
 - feature description 97
 - queuing
 - priorities 97
- Call Timer 157
- Callback 67
- Calls
 - incoming 73
- Camp** denied
 - Camp On 98
- Camp On
 - Call Queuing 99
 - feature description 98
 - ringing 69
- Can't ring again
 - Dialing 115
- Can't send msg
 - Message 133
- Cancel
 - feature 66
- Cancel denied
 - Message 133
- Cancel for
 - Message 134
- Capabilities
 - Dialing filters 36
 - Line filters 47
 - User filter 47
- Class of Service 154
- Class of Service passwords 45
 - copying data 46
 - Line filter 47
 - number of 46
 - User filter 47
- Compact DR5 Telephone
 - Feature Card 15
- Conference
 - disconnect one party 100
 - feature description 100
 - independently hold two calls 100
 - on M7100 telephone 103
 - put on hold 101
 - split 101
 - with Privacy 100
- Conf**erence busy
 - Conference 102
- Configuration 154
- Configuration programming 1
- Contrast Adjustment 105
- Control telephone

assigning to lines 48
Copy
 line programming 57
 telephone programming 57
COS Line filters (see Line filters (COS))
COS Password
 Changing 104
 feature description 104
COS passwords 45
Customizing Norstar 13
Customizing 16
Customizing the telephone
 Contrast Adjustment 105
 Dialing modes 106
 Handsfree 105
 Language 107
 moving line buttons
 feature description 108
 Pulse/Tone Dialing 109
 ringing 109

D

Defaults
 Dialing filters 38
Delayed Ring Transfer 67
Denied in **admin**
 Service modes 145
Dialing
 direct dial 112
 Pulse or Tone 109
 unrestricted 38
Dialing filters
 defaults 38
 deleting 39
 number of 38
Dialing Modes
 Automatic 106
 Pre-Dial 106
 Standard 106

Direct -dial telephone 147
 Directed Pickup
 feature description 94
 Directory Numbers 154
 Disconnect Protection 153
 Display
 one-line 64
 two-line 64
 Displays
 Prime telephone 72
DND 71
Do Not Disturb 68, 78, 159,
 160
 feature description 117.

E

Emergency calls
 Priority call 143
Emergency telephone 148
Enter code
 Speed dial 151
Enter zone
 Page 142
Exceptions
 removing 38
Exceptions in a Dialing filter 39
Exclusive Hold 125
 feature description 125
Extension numbers (See
 Directory Numbers)
External Autodial 74
External call
 ringing 69
External line Access Code 112
External lines
 Line/telephone filter 40
Extra-Dial
 additional Direct-Dial 5-l
Extra-dial telephone 148

F

Feature Button 137.
 Feature Buttons 138
 Feature Programming 118
 Features
 canceling 66
 overview 64
 Restrictions 41
 Filter
 Line 45
 User 47
F i l t e r s
 Line with COS 47
 Line/telephone 40
 Forwarding (see Call Forward)
 Call forward No Answer 44
 Call Forward On Busy 43
 Full Handsfree
 programming 41

G

Get call first
 Call Park 92
 Group Listen
 feature description 121
 Group Pickup
 feature description 94

H

Handsfree
 Automatic 42
 etiquette 123
 Full Handsfree 42
 Handsfree Answerback 42
 Handsfree/Mute 68
 feature description 122
 Headset
 answering a call 139
 Full Handsfree 42

 Operating 139
 Hold
 feature description 124
 Listen on Hold 124
 Music, Tones or Silence 125
 on M7100 telephone 125
 Hold Button 137
 Hold or **rel** ease
 feature programming 119
 Host System Signaling 126
 Link 126
 pause 126
 Programmed Release 127
 Run/Stop 127
 Timed Release 127
 Hotline
 programming 45
 Hotline telephone 148

Indicators 69
 Internal Autodial 74
 Internal call
 ringing 69
 Internal numbers (See
 Directory Numbers)
Invalid zone
 Page 142

L

Language choice 107
 Last Number Redial
 feature description 112
 Line
 buttons
 moving 108
 Indicators on telephones 69
 Names 30
 Line Abilities
 Line Filter 45

Line appearance 155
 Line Buttons 138
 Line filter
 defaults 45
 Line filters (COS)
 defaults 47
 Programming 47
 Line in use
 Hotline 149
 Line Pool
 Hotline 44
 System Speed Dial 27
 Line Pools 155
 feature description 129
 Ring Again 130
 Line Supervision 154
 Line/telephone filters
 number of 40
 Lines
 Prime 155
 Private 155
 Ringing preference 156
 Link 126
 feature description 126
 Listen on Hold 124
 Logit
 feature description 83

M

M7100telephone
 Conferencing 103
 display buttons 64
 Hold 125
 selecting lines 66
 M7208 telephone
 display buttons 64
 Make call first
 Camp On 99
 Make calls first
 Conference 102

Memory Button, 137
 erasing 118
 Memory buttons
 programming 118
Message denied
 Message 134
 Message Waiting 11
 Message Waiting List
 call from 132
 Messages
 feature description 131
 Message Waiting List 132
 Voice Message Center 136
 Music on Hold 125

N

Name
 System Speed Dial 28
 Names
 entering letters 24
 Length 29
 Moving Telephones 29
 Programming 29
 Valid characters 29
 Need **Handsfree**
 Headset 140
 Night **Service**
 Service modes 145
 No **button free**
 Dialing 115
 Message 135
 No calls waiting
 Answering the telephone 70
 No last number
 Last number redial 115
 No line selected
 Answering the telephone 71
 Dialing 115
 Hotline 149
 No number saved

Saved Number redial 115

No saved number

Saved Number redial 116

No **voice** call

Voice Call 163

Not in **service**

Camp on 99

Numbers

entering 23

viewing 23

O

On-hook dialing 106

P

Page

feature description 141

zones 141

Page timeout

Page 142

Page Zone

programming 42, 43

Paging

Zones 42, 43

Paging busy

Page 142

Park denied

Call Park 93

Parking full

Call Park 93

Password

Administration 52

Pause

feature description 126

Personal programming 1

Personal Speed Dial 150

Pick UP receiver

Call Queuing 71

Pickup

Call Pickup programming 42

Pre-Dial 106

Prime Line

Hotline 44

Prime lines 155

Prime telephone 68, 149

Priority Call

feature description 143

ring 69

Privacy

creating a conference 100

Private lines 155

Call Pickup 42, 95

Program and HOLD120

Programmed Release

feature description 127

Programming

Automatic Handsfree 42

Auxiliary Ringer 43

Call Forward No Answer 44

Call Forward On Busy 43

Call Pickup (group) 42

Capabilities 36

COS Line filter 47

features 118

Full Handsfree 41

Handsfree Answerback 42

Hotline 45

Names 29

Page Zone 42, 43

preparing for 14

purpose 13

reminders 58

Service Mode name 49

Service Modes 48

telephone filter 35, 40

tools 15

Trunk Answer 51

using display buttons 22

Programming Overlay 19

Programming Record 15

Pulse dialing 109

R

Receive tones 44

Redirect Ring 69

Release a call

 Answering the telephone 71

Release button 138

Relocating

 telephones 153

Restricted call

 Dialing 116

Restrictions

 bypassing 28

 for External Users 36

 for Internal Users 36

 number of 38

 removing 38

Restrictions in a Dialing filter

 39

Ring Again

 feature description 112

Ring type 110

Ringling

 Changing the ring

 feature description 109

 On/Off for lines 156

 Service Modes 51

 Volume

 feature description 110

Run/Stop

 Feature description 127

S

Saved Number Redial

 feature description 113

Service Modes 48

 Auxiliary Ringer 51

 canceling 145

 Control telephone 48, 145

Default start and stop times

 50

Extra-dial telephone 51, 148

feature description 145

ON and OFF 49

programming 48

Ringling 51

Service Modes 2 and 3 49

Trunk Answer 51

Signaling

 Host System 126

Speaker

 Paging 141

 Telephone 42

Speed Dial

 Class of Service 152

 feature description 150

 personal programming 150

Standard Dial 106

Supervision 155

System Coordinator's role 1

System Speed Dial 156

 bypassing restrictions 28

 changing name 28

 Display Digits 27

 programming 25

T

Telephone

 Administration lock 1 10

 Alarm 147

 Control 147

 Customizing 105

 Direct-Dial 35, 147

 Emergency 148

 Extra-Dial 148

 Hotline 148

 Names 29

 Prime 68, 149

Telephone Abilities

Automatic Handsfree 42
Auxiliary Ringer 43
Call forward No Answer 44
Call Forward On Busy 43
Call Pickup (group) 42
Direct-Dial Telephones 43
Full Handsfree 41
Handsfree Answerback 42
Hotline 44
Line/telephone filter 40
Page Zone 42, 43
Priority Call 45
Telephone Administration
 Lock 4-1
Telephone buttons
 Norstar Telephones 137
Telephone relocating 153
Telephone User Cards 15
Telephones
 Direct-Dial 43
Their list full
 Message 135
Time
 display 157
 feature description 157
Time and Date
 setting the date 33
 setting the time 33
Timed Release
 feature description 127
Timer
 for calls 157
Tone dialing 109
Tones
 Receive tones 44
Transfer
 enhanced for DR5 2

 feature description 158
 using conference 158
 with announcement 158
Transfer denied
 Transfer 161
Trunk Answer
 feature description 94
 programming 51

U

Upgrading
 Class of Service passwords
 46

V

Voice Call 141
 deny 162
 feature description 162
 Handsfree Answerback 42,
 162
 muting tones 162
Voice Call Deny 68
 feature description 162
Voice Message Center
 telephone numbers 56
Volume
 Button 138

Y

Your list full
 Message 135
 Line/telephone filter 36
 Page Zone 38, 39
 Priority Call 41
 Telephone Administration
 Lock 37

norstar

.....
telemanuals.com

Compact DR5
Programming Record

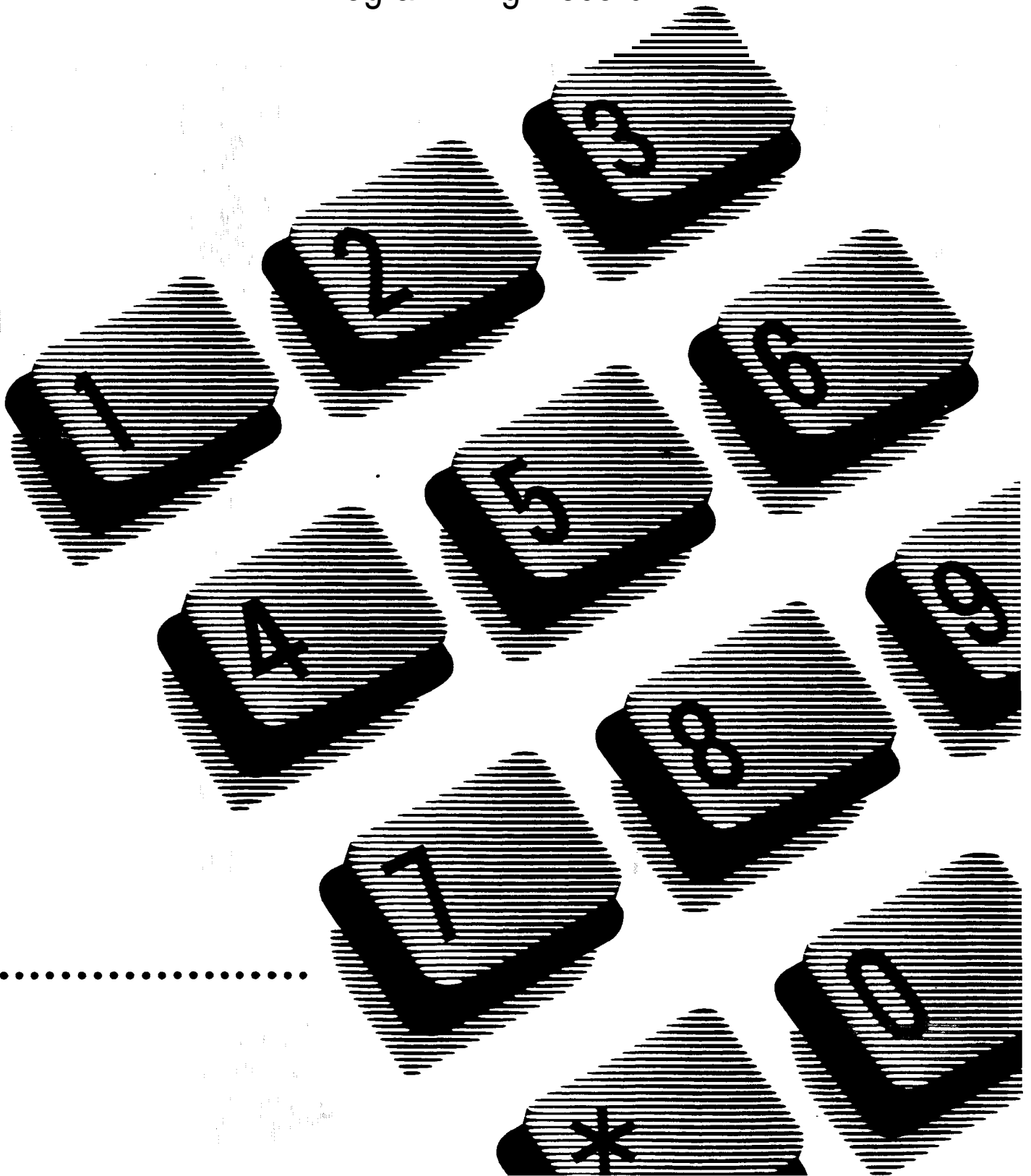

Compact DR5 Programming Record

Customer/Company:	Sales Representative:
Address:	Telephone:
	Issue date:
Telephone:	
Billing number:	Installer:
System Coordinator:	Installation date:
Notes: .	

Installed equipment

Key Service Unit		Data Terminals
Key Service Unit (KSU)		Analog Terminal Adapter (ATA)
Call Identification Interface		
Telephones		Auxiliary equipment
M7100		External Paging Equipment
M7208		External Music source
M7310		Station Auxiliary Power Supply
M7310 with Busy Lamp Field (BLF)		Auxiliary Ringer
M7324		Headset
M7324 with 1 Central Answering Position (CAP)		Shoulder rest
M7324 with 2 Central Answering Positions (CAP)		Radio Frequency (RF) Filter Kit
Single-line telephone		
Emergency telephone		

Notes about this Programming Record

- defaults in the Programming Record, shown in bold text, are defaults for the Square template.
- before using the sheets provided, FIRST photocopy the sheets for which multiple pages are required.
- this record contains enough sheets for 4 lines and 4 telephones.

Service, modes (General admin: 6. Service Modes)

Control sets	Line: W	Line Name:	<input type="text"/>	Control set: 21	<input type="text"/>				
	Line: W	Line Name:	<input type="text"/>	Control set: 21	<input type="text"/>				
	Line: W	Line Name:	<input type="text"/>	Control set: 21	<input type="text"/>				
	Line: W	Line Name:	<input type="text"/>	Control set: 21	<input type="text"/>				
	Line: W	Line Name:	<input type="text"/>	Control set: 21	<input type="text"/>				
	Line: W	Line Name:	<input type="text"/>	Control set: 21	<input type="text"/>				
Name: (max. 7 char.)	Night		Evening		Lunch				
Setting *	Manual	Off	Auto	Manual	Off	Auto	Manual	Off	Auto
If Auto is selected									
Start time	23:00	Hr: W	Min: W	17:00	Hr: W	Min: W	12:00	Hr: W	Min: W
Stop time	07:00	Hr: W	Min: W	23:00	Hr: W	Min: W	13:00	Hr: W	Min: W
Trunk answer	Y	N		Y	N		Y	N	
Extra-dial telephone (max. 2 digits)	21 <input type="text"/>			21 <input type="text"/>			21 <input type="text"/>		
Ringing Sets	Line	Telephone	Aux.Ring	Line	Telephone	Aux.Ring	Line	Telephone	Aux.Ring
	<input type="text"/>	21	Y N	<input type="text"/>	21	Y N	<input type="text"/>	2 1	Y N
	<input type="text"/>	<input type="text"/>	Y N	<input type="text"/>	<input type="text"/>	Y N	<input type="text"/>	<input type="text"/>	Y N
	<input type="text"/>	<input type="text"/>	Y N	<input type="text"/>	<input type="text"/>	Y N	<input type="text"/>	<input type="text"/>	Y N
	<input type="text"/>	<input type="text"/>	Y N	<input type="text"/>	<input type="text"/>	Y N	<input type="text"/>	W	Y N
	<input type="text"/>	<input type="text"/>	Y N	<input type="text"/>	<input type="text"/>	Y N	<input type="text"/>	<input type="text"/>	Y N

Password (General admin: 7. Password)

Admin. password (max. 6 digits)	The default is (ADMIN) or (23646). <input type="text"/>
---------------------------------	---

Call Log size (General admin: 8. Log Defaults)

Log size:	<input type="text"/>
-----------	----------------------

Voice Message Center Telephone Numbers (General admin: 9. Call Services) (max. 24 digits)

VMSa center 1 #	<input type="text"/>
VMSg center 2 #	<input type="text"/>
VMSg center 3 #	<input type="text"/>
VMSg center 4 #	<input type="text"/>
VMSg center 5 #	<input type="text"/>

To record programming for more than four lines, photocopy this page **BEFORE** using.

Line programming

line: (2 digits)	<input type="text"/>	<input type="text"/>	<input type="text"/>	<input type="text"/>
name: (max. 7 char.)	<input type="text"/>	<input type="text"/>	<input type="text"/>	<input type="text"/>
number: (max. 7 digits)	<input type="text"/>	<input type="text"/>	<input type="text"/>	<input type="text"/>

Trunk Data (Configuration: 1. Trk/Line Data)

copied from:				
Dial mode	Pulse Tone	Pulse Tone	Pulse Tone	Pulse Tone
Full AutoHold	Y N	Y N	Y N	Y N

Line Data (Configuration: 1. Trk/Line Data)

copied from:				
Line type	Public Private to: _____ Pool: (A-C) _____	Public Private to: _____ Pool: (A-C) _____	Public Private to: _____ Pool: (A-C) _____	Public Private to: _____ Pool: (A-C) _____
Prime set	2 1 None w 2	1 None w 2	1 None w 2	1 None W
Aux. ringer	Y N	Y N	Y N	Y N
Auto orivacv	Y N	Y N	Y N	Y N

Line Abilities (General admin: 5. Capabilities)

copied from line:				
Line filter	l 03	l 03	l 03	l 03

Call Services (General admin: 9. Call Services)

Auto Call Info	None <input type="text"/>	None W	None W	None W
copied from line:				
VMsg center #	1 2 3 4 5 N	1 2 3 4 5 N	1 2 3 4 5 N	1 2 3 4 5 N

record programming for more than four telephones, photocopy the following tables BEFORE using.

Set programming

Set: (max. 2 digits)			
Name: (max. 7 char.)			
Modem:			

Set Copy (enter set and circle S for system data or SU for system and user data)

Copied from set:	S su	S su	S su	S su
------------------	------	------	------	------

Line Access (Configuration: 2. Line Access)

Copied from:				
Line Assignment	0 1 Ring No ring 0 2 Ring No ring ___ Ring No ring ___ Ring No ring ___ Ring No ring ___ Ring No ring	01 Ring No ring 02 Ring No ring ___ Ring No ring ___ Ring No ring ___ Ring No ring	0 1 Ring No ring 02 Ring No ring ___ Ring No ring ___ Ring No ring ___ Ring No ring	01 Ring No ring 02 Ring No ring ___ Ring No ring ___ Ring No ring ___ Ring No ring
Answer DNs	___ Ring No ring ___ Ring No ring ___ Ring No ring ___ Ring No ring	___ Ring No ring ___ Ring No ring ___ Ring No ring ___ Ring No ring	___ Ring No ring ___ Ring No ring ___ Ring No ring ___ Ring No ring	___ Ring No ring ___ Ring No ring ___ Ring No ring ___ Ring No ring
Line pool access	A B C	A B C	A B C	A B C
Intercom buttons	0 1 2	0 1 2	0 1 2	0 1 2
Prime line	None Intercom Line#:____ Pool- -	None Intercom Line#:____ Pool- -	None Intercom Line#:____ Pool- -	None intercom Line#:____ Pool* -

Set abilities (General admin: 5. Capabilities)

Copied from set:				
Set filter (2 digits)	02	02	02	02
Line/set filters	Line* - Filter:- Line: - Filter:- Line: - Filter:____ Line: - Filter:- Line: - Filter:____ Line: - Filter:____	Line:- Filter:- Line: - Filter:____ Line:- Filter:____ Line____ Filter:____ Line: - Filter:____ Line:- Filter	Line:- Filter:____ Line: - Filter -- Line* - Filter -- Line: - Filter:____ Line - Filter -- Line:- Filter:- Line* - Filter	Line: - Filter -- Line* - Filter -- Line: - Filter:____ Line - Filter -- Line:- Filter:- Line:- Filter:- Line:- Filter
Set lock	None Full Partial	None Full Partial	None Full Partial	None Full Partial
Full handsfree	Y N	Y N	Y N	Y N
Auto handsfree	Y N	Y N	Y N	Y N
IF answerback	Y N	Y N	Y N	Y N
Pickup group	NO 1 2 3 4	NO1 2 3 4	NO1 2 3 4	NO1 2 3 4
Paging	Y N	Y N	Y N	Y N
Page zone	NO 1 2 3	NO1 2 3	NO1 2 3	NO1 2 3
Aux. ringer	Y N	Y N	Y N	Y N
Direct-dial	Set1 None	Set1 None	Set1 None	Set1 None
Forward on busy	None or to:	None or to:	None or to:	None or to:
Forward no answer	None or to:	None or to:	None or to:	None or to:
Forward delay	2 3 4 6 10	2 3 4 6 10	2 3 4 6 10	2 3 4 6 10
Receive tones	Y N	Y N	Y N	Y N
Hotline	None Intml Extml	None Intml Extml	None Intml Extrnl	None Intrnl Extrnl
Priority call	Y N	Y N	Y N	Y N

Set Services (General admin: 9. Call Services)

cooled from:

Autolog/Show VMsg	Line _____	Y N	Line _____	Y N	Line _____	Y N	Line _____	Y N
	Line _____	Y N	Line _____	Y N	Line _____	Y N	Line _____	Y N
	Line _____	Y N	Line _____	Y N	Line _____	Y N	Line _____	Y N
	Line _____	Y N	Line _____	Y N	Line _____	Y N	Line _____	Y N
	Line _____	Y N	Line _____	Y N	Line _____	Y N	Line _____	Y N
	Line _____	Y N	Line _____	Y N	Line _____	Y N	Line _____	Y N
Show extl VMsg	Line _____	Y N	Line _____	Y N	Line _____	Y N	Line _____	Y N
	Line _____	Y N	Line _____	Y N	Line _____	Y N	Line _____	Y N
	Line _____	Y N	Line _____	Y N	Line _____	Y N	Line _____	Y N
	Line _____	Y N	Line _____	Y N	Line _____	Y N	Line _____	Y N
	Line _____	Y N	Line _____	Y N	Line _____	Y N	Line _____	Y N
	Line _____	Y N	Line _____	Y N	Line _____	Y N	Line _____	Y N

Log Space

1 st Display	Name Number LineName	Name Number LineName	Name Number LineName	Name Number LineName
--------------	----------------------------	----------------------------	----------------------------	----------------------------

Programming glossary

1st display	Select the first information to be displayed by the Call Display features. The default is Name. Other settings are Number and Line. Name or Number only appear if you have subscribed to Call Display services, otherwise line name will appear as the default.
Admin. password	Assign a 1 to 6-digit password for security. The default is ADMIN (23646).
Answer DNs	Up to four buttons on a telephone can be programmed for answering calls to the DNs of other telephones. The default is No Answer DNs . Enter the DNs of other telephone DNs to appear on answer buttons at this telephone.
Auto Call Info	Lets you identify the telephone that will automatically display Call Display information for a specific alerting line (providing you have subscribed to Call Display services).
Auto handsfree	Choose Yes to allow automatic activation of Handsfree capability.
Auto privacy	Lets you program settings for physical trunks. Choose Yes to prevent other users, who have access to this line on their telephones, from using the line while a call is already in progress.
Autolog/ShowVMsg	A section of programming that lets you program whether or not the telephone is able to automatically log call information for calls on a specific line and whether Message Waiting information is displayed (providing you have subscribed to Call Display services).
Auxiliary ringer	Choose Yes for an Auxiliary Ringer (if installed) to ring for an incoming call on a specific line or at a specific telephone. The default is Yes for ringing on specific lines, and No for ringing at specific telephones.
Backgrnd music	Choose Yes to hear music through the telephone's speaker (music source must be connected). The default is No.
Bypass restriction	Choose Yes to allow a user to bypass restrictions or retain the default No to prevent bypass when using a Speed Dial number.
Call Handling	A sub-heading for a programming section that lets you program system-wide settings for various call features.
Call Services	A sub-heading for a programming section that lets you program settings for Voice Messaging, External Visual Message Waiting indication, Call Display Information and Call Logs.
Camp timeout	Choose the number of seconds a call can remain camped before it returns to the originating telephone. The default is 45 seconds.
Capabilities	A sub-heading for a programming section that lets you create Dialing filters. Assign the filters to Set abilities, Line abilities and Class of Service passwords.
Configuration (Installer only)	A heading for a programming section that lets you program system-wide configuration settings.
Control sets	Assign a control telephone to each external line to turn the Service Mode ON or OFF for the line. The default control telephone is DN 21. Enter the numbers for the line(s), the name of the person who uses the telephone and the new DN if changed.
COS passwords	Create up to 20 six-digit passwords that control access and use of the Norstar system.
Dial mode	Lets you program settings for physical trunk lines. Select the mode of dialing on this line: Pulse or Tone. The default is Pulse.
Dialing filters	Build tables of up to 25 Dialing filters (00 to 24) using restrictions and exceptions.
Direct dial #	Assign the digit used to dial a Direct-dial telephone. The default is 0. The digit can be 0, 1, 2, 3, 4, 5, 6, 7, 8, 9 or None. It cannot be the same as the first digit of a DN, of a Line Pool access code, the External Line access code or the Call Park Prefix.
Direct-dial	A sub-heading for a programming section that lets you assign a Direct-dial telephone for single-digit dialing.
Directed pickup	Directed Pickup allows you to answer calls at any telephone by specifying the ringing telephone's number (unlike Call Pickup Group which only allows pickup of calls within a specified group of telephones). The default is Yes.
Display digits	Retain the default, Yes, to see the telephone number on the display when using the speed dial number or change the setting to No to turn off the display.
DRT delay	If "DRT to prime" is activated, assign the number of rings before a call is transferred. Default is 3 rings .

DRT to prime,	Delayed Ring Transfer automatically forwards unanswered external calls to a Prime telephone . Choose Yes to activate DRT.
Exceptions	Enter any number of exceptions to the restrictions, as long as the total number of restrictions and exceptions for the system does not exceed 200.
External code	Assign the one digit External line access code , or none. This code allows an M7100 Telephone or an ATA to access external lines.
Extra-dial telephone	If a Direct-dial telephone is also a Control telephone for a Service mode, you can specify an Extra-dial telephone at which all calls made to the Direct-dial telephone will also ring. The default Extra-dial telephone is 21.
Filter	<p>Enter a dialing filter number. Then enter the first restriction to be assigned. Enter all the exceptions to a restriction before writing in the next restriction or the next filter number.</p> <ul style="list-style-type: none"> Copy the contents of one filter to a new filter for easier programming. Remember to record all the restrictions and exceptions assigned to each filter. <p>Preset and default filter assignments:</p> <p>Filter 00 — pre-set for No restrictions (the setting cannot be altered). Filter 01 — pre-set with five restrictions and related exceptions (but is re-programmable).</p> <p>Restr'n 01: 0 Restr'n 02: 1 Excpt'n 001: 1800 Excpt'n 002: 1555 Excpt'n 003: 1'1'555 Excpt'n 004: 1'0'555</p> <p>Restr'n 08 911 Excpt'n 001: 911 Restr'n 04: 411 Restr'n 05: 976</p> <p>Filter 02 — is the unrestricted default filter for Set abilities, Set filter. Filter 03 — is the unrestricted default filter for line abilities, Line filter.</p>
Forward no answer	To redirect calls that have gone unanswered at the telephone, enter the DN of a Norstar telephone to which the calls should go- If "Forward no answr " is activated, Forward delay sets the number of rings before the call is forwarded. The default is 3 rings. Other options are 2, 4, 6 and 10 rings.
Forward on busy	To redirect all incoming calls to your telephone, when you are busy with another call, enter the DN of another Norstar telephone to which the calls should go.
Full AutoHold	Lets you program settings for lines. The default is No. Choose Yes only if you want to be able to put an idle line on hold to reserve it while you select another line (for example, to answer a call).
Full handsfree	Choose Yes to allow a user to make or receive calls without picking up the receiver or to allow the use of a headset on a Norstar teleohone.
General admin	A heading for a programming section that lets you program system-wide settings and specific settinos for each line or Norstar teleohone.
Held line reminder	Choose Yes to program the telephone to remind you when a call is on hold. Two tones sound periodically until the call is answered. The default is No.
HF answerback	Choose Yes to allow a user to answer a Voice Call without lifting the receiver.
Host delay	Choose the delay in milliseconds between the selection of an outgoing line and the moment that Norstar sends dialed digits or codes on that line. The default is 1000 milliseconds.
Hotline	Assign a telephone number to be called automatically when a user lifts the receiver or presses Handsfree . Retain the default None if no hotline is needed. Choose Intml to assign an internal Norstar telephone as the hotline. Choose Extml to make an external telephone the hotline. By default, the Extml setting uses the Prime line (Use prime line) to make the call. Choose the Use line: _ setting to assign an external line number or choose Pool code: _ to assign the access code of line pool for making the call.

Individual DNs	Change the Directory Number (DN) of a telephone. All DNs must be the same length. The first digit of a new DN cannot be the same as the External Line access code or 0. Note: Changing an individual DN locks the configuration session into System Data mode, and when the session ends, you have to m-enter the Configuration access code and the Installer password to continue with programming.
Installer password	Change the one to six character Installer password used to enter Configuration programming from the default of CONFIG (266344).
Intercom buttons	Choose the number of intercom buttons on the telephone (default is 2) for access to internal lines.
Line abilities	A section of programming that lets you apply dialing filters to lines.
Line Access	A sub-heading for a programming section that lets you program settings for each telephone.
Line assignment	Enter the line numbers of the lines to be assigned to the telephone (default assignments are lines 01 and 02). Each line assigned to a telephone must appear at a button with an indicator on the telephone, (except for the M7100 Telephone which has no line buttons and can be assigned any number of lines).
Line data	A section of programming that lets you program settings.
Line fltr	Enter a two-digit filter number to temporarily replace the Line filter assigned to this line. The default (Deflt) allows a filter programmed previously to continue to apply.
Line filter	Retain default filter 03 defined previously in Dialing filters programming or assign another two -digit filter number to the line.
Line names	Identify a line by the name of its destination or by the trunk type (up to seven characters).
Line pool access	Choose the Line Pools (A to C) to which the telephone user will have access. The default is No for all pools.
Line pool codes	Assign the Line Pool access codes for each Line Pool used. A code can be one to four digits in length (Line Pool access codes have no defaults). A line pool code cannot start with the first digit of any DN (including Rec'd #s) the call park prefix or the Direct-dial digit.
Line type	Lets you program settings for physical trunks. Choose Public to be able to assign the line to any telephone. Choose Private to: to make the line private. Enter the DN of the telephone to which the line is to be assigned. Choose Pool to select Line Pool (A to C) to which the line will belong. Note: See the Configuration chapter in the Norstar Installer Guide for specific guidelines on setting up line pools.
Line/set filters	Enter the three-digit number of a line assigned to the telephone. Assign a two-digit filter from Dialing filters to replace any line or set filters that might otherwise apply to that particular line. You can assign up to 255 Line/set filters.
Link time	Link time specifies the duration of a signal required to access a feature through a remote system. The default is 600 milliseconds.
Log Defaults	A sub-heading for a programming section that lets you re-allocate system call log space for all telephones.
Log password	Set the call log password for a telephone to default, erasing any user inserted password. The default is No Password.
Log space	Reallocate the call log space on a telephone-by-telephone basis.
Logging set	Identify the telephone(s) that will automatically receive call log information for a specific line (providing you have subscribed to Call Display services).
Miscellaneous	A sub-heading for a programming section that lets you program various system-wide settings.
Name	This option only appears if Display digits for Speed Dial is set to No. Enter up to 16 characters to see a name (such as: COURIER) instead of a telephone number on the display.
Name1, Name2 , Name3	Retain the default Service Mode names or enter new names (up to 7 characters).
Names	A sub-heading for a programming section that lets you assign meaningful names to telephones and lines.

On hold	A caller waiting oh hold will hear Music (from a source such as a radio connected to the KSU), periodic Tones or Silence. The default is Tones.
Paging	Allows announcements to be made from a Norstar telephone. The default is Yes.
Page zone	By default, a telephone falls into Page Zone 1. Enter a digit from 2 to 3 to change the page zone for this telephone, or change the setting to No to prevent pages to this telephone.
Park prefix	Assign the code number to retrieve a parked call. The default is 1.
Park timeout	Choose the number of seconds a call on an external line can remain parked before it returns to the originating telephone. The default is 45 seconds.
Password	A sub-heading for a programming section that lets you allow authorized persons to have access to General administration programming.
Pickup group	Enter a digit from 1 to 4 for your Pickup Group to be able to answer any calls ringing at another telephone in your group or retain the default No to disable the feature.
Prime line	Assign a Prime line to the telephone. The Prime line is the first line selected automatically for making calls from the telephone. To assign a line or line pool as Prime line, the line or line pool must have been assigned to the telephone. Choose None for no Prime line (default). Choose Line to select an external line as the Prime line. Choose Pool to select a Line Pool (A to C) as the Prime line. Choose WC to select an internal line (intercom) as the Prime line.
Prime set	A Prime telephone can provide backup answering of calls on the line. The default Prime telephone is DN 21. To change the Prime telephone for this line, enter the DN of another telephone, or choose None for no Prime telephone.
Receive tones	A section of programming that lets the system accept and relay tone to the TCP lines.
Remind delay	If Held Line Reminder is Yes, assign a delay before HLR begins for a call. The default is 60 seconds.
Reset all logs	Re-allocate the call log space on a system-wide basis. The system total of 160 log spaces can be distributed to the telephones.
Restrictions	Enter up to 46 restrictions for a dialing filter as long as the total number of restrictions and exceptions for the system does not exceed 200.
Ringing	In the Programming Record, list the line numbers which are assigned to ring at the telephone. Also list the Answer Group DNs which are assigned to ring at the telephone. The defaults for all trunk lines is Ring. The default for Answer Group DNs which are assigned to ring at the telephone is Ring.
Service Modes	A sub-heading for a programming section that lets you assign telephones to ring during specified periods of the dav.
Set abilities	A section of programming that lets you apply dialing filters and permissions to telephones.
Set Copy	A heading for a programming section that lets you copy programming from one telephone in the system to another.
Set filter	Retain the default filter 02, or assign another two-digit filter number from Dialing filters programming.
Set lock	To limit personal programming and customization that can be performed at this telephone, change from the default None to Full or Partial. as necessarv .
Set names	Identify a telephone by the name of a person or its location (up to seven characters).
Set relocation	Set relocation permits a telephone to be moved from one location within the Norstar system to another without losing the settings programmed on it. The default is No or OFF.
'Set Services	A sub-heading for a programming section that lets you control some specific attributes of call log information.
Set1	Enter the DN for the Direct-dial telephone. Remember that other Direct-dial programming is required in Configuration (4. Miscellaneous) and General admin (5. Capabilities).
Setting	Manual (the default) allows you to turn the Service Mode On or Off at any time from the control telephone. Change the setting to Off to disable Service Mode, or change it to Auto to assign automatic Start/Stop times.
Show ExtlVmsg	Identify the telephone that will give voice message waiting indication for messages on a specific line (providing you have subscribed to Call Display services).

Show Line	Enter the number of an external line which requires additional ringing telephones (a line can have multiple ringing telephones).
Ringing Sets Auxiliary ringer	Enter the DNs of the telephones that should ring for calls on that line. You can also make the Auxiliary ringer ring for calls on that line.
Speed dial #:_ Use prime line, Use line:-, Pool code :_	Assign telephone numbers (up to 24 digits) to the speed dial codes 01 to 70. Choose whether to use the Prims line (the default), another external line, or a line pool with Speed dial numbers'
Start time: Stop time:	Use the default Start/Stop times shown on the Programming Record or assign new times for Service Modes.
System-speed dial	A sub-heading for a programming section that lets you assign up to 70 2-digit speed dial numbers that can be dialed from Norstar telephones.
System Data	A sub-heading for a programming section that lets you re-assign a telephone's internal number or change the lengths of all internal numbers and of Received numbers.
System Version	A sub-heading for a programming section that informs you of the system version.
Time and date	A sub-heading for a programming section that lets you set the system's clock.
Trunk/Line Data	A sub-heading for a programming section that lets you program physical trunks in Trunk Data. Program physical trunk lines in Line Data programming.
Transfer callback	Assign the number of times that a call you transfer is allowed to ring before the call returns to your telephone. Default is 3 rings.
Trunk answer	Set Trunk answer to Yes to allow external calls to be answered by any telephone, regardless of where the call rings.
Trunk data	A section of programming that lets you program settings for physical trunk lines only.
User filter	Enter a two-digit filter number to temporarily replace the Set filter or Line/set filter assigned to this telephone. The default (Defit) allows a filter programmed previously to continue to apply.
VMsg center tel#s	Program the telephone numbers required to access up to five different Voice Message Centers using the callback function of the Message Waiting feature (providing you have subscribed to Call Display services).
VMsg tel#s -> lines	Program which of the five Voice Message Centers are to be accessed by each specific line. Valid settings are Voice Message Center 1, 2, 3, 4, 5 , and None. The default setting for all lines is Voice Message Center 1.

Programming defaults

A. Configuration

1. Trk/Line Data (p. 7)

Show line: _
Trunk data

Dial mode	Pulse	Tone
Full AutoHold	Y	N

Line data

Line type	Public	Private to: Pool
Prime set	21	(any DN), None
Aux. ringer	Y	N
Auto privacy	Y	N

2. Line Access (p. 8)

Show set: _

Line assignment	01,02,03,04,05,06	ADD or REMOVE line
Answer DNs	No Answer DNs	Add DN
Ringing (All assigned Trunk lines)	Ring	No Ring
Line pool (A-C) access	Y	N
Intercomkeys	2, 1, 0	
Prime fine	None	Pool A to C, 01 to 06, 1/C

3. Call Handling (p. 3)

Held line reminder	Y	N
Remind delay (if HLR=Y)	30, 60, 90, 120, 150, 180	
DRT to prime	Y	N
DRT delay (if DRT = Y)	1, 2, 3, 4, 6, 10	
Trnsfr callbk	3, 4, 5, 6, 12	
Park prefix	0, 1, 2, 3, 4, 5, 6, 7, 8, 9, None	
Park timeout	30, 45, 60, 90, 120, 150, 180, 300, 600	
Camp timeout	30, 45, 60, 90, 120, 150, 180	
Directd pickup	Y	N
On hold	Tones	Music, Silence

4. Miscellaneous (p. 3)

Backgrnd music	Y	N
Direct-dial #	0, 1, 2, 3, 4, 5, 6, 7, 8, 9, N	
Link time	100, 200, 300, 400, 500, 600, 700, 800, 900, 1000	
Set relocation	Y	N
Host delay	200, 400, 600, 800, 1000, 1200, 1400, 1600, 1800, 2000	
External code	0, 1, 2, 3, 4, 5, 6, 7, 8, 9, (blank)	
Line pool codes (Pools A to C)	1 to 4 valid digits	
Installer pswd.		

'System Data (p. 3)

Individual DNs Old_ New-

B. General admin

1. Sys speed dial (p. 4)

(24 digits)	#01:0 #70
Number	No number stored
Line	Line# Prime! Pool code
Display digits	Y N
Name	Sys Spd Dial # max. 16 characters
Bypass restr'n	Y N

2. Names (pp. 7, 8)

Set names	max. 7 characters
line names	max. 7 characters

3. Time and date

set accordingly

4. Direct-Dial (p. 4)

Set1:	21	None, DN
-------	----	----------

5. Capabilities (pp. 5, 7, 8)

Dialing filters	Show filter: _
Filter 00	No restriction
Filter 01	
Restr'n	Excp'n
01	0 ----
02 1	001 1800
	0 0 2 1555
	003 1'1'555
	004 1'0'555
03 911	001 911
04 411	-----
05 9 7 6	-----
Filters 02 to 24	No restriction

Set abilities

Show set: _	
Set filter	02
Line/set filters	None
Show line: _	
Set lock	None: Full, Partial
Full handsfree	Y N
Auto handsfree	Y N
HF answerback	Y N
Pickup group	NO: 1 to 4
Paging	Y N
Page zone	1
	2,3, NO
Aux.ringer	Y N
Direct-dial:	Set1 None
Forward on busy	Forward to: None
Forward no answr	Forward to: None
	Forward delay 2, 3, 4, 6, 10
Receive tones	Y N
Hotline	None
	Intrnl, Extml
Priority Call	Y N

Line abilities

Show line: _	
Line filter	03
COS passwords	Show password: _
Pswd	None
User fltr:	Deflt
Line fltr:	Deflt

6. Service Modes (p. 6)

Control sets	Show line: _
Set	21

Name

Name:	Night
Change:	(7 characters)
Setting	Manual Off Auto
Start (if setting is Auto)	23:00
Stop (if setting is Auto)	07:00
Trunk answer	Y N
Extra-dial set	21
Show line: _	
Ringing Sets	21
Aux. ringer	Y N

Name 2

Name:	Evening
Change:	(7 characters)
Setting	Manual Off Auto
Start (if setting is Auto)	17:00
Stop (if setting is Auto)	23:00
Trunk answer	Y N
Extra-dial set	21
Show line: _	
Pinging Sets	21
Aux. ringer	Y N

Name 3

Name:	Lunch
change:	(7 characters)
Setting	Manual Off Auto
Start (if setting is Auto)	12:00
Stop (if setting is Auto)	13:00
Trunk answer	Y N
Extra-dial set	21
Show line: _	
Ringing Sets	21
Aux. ringer	Y N

7. Password (p. 6)

Default:	ADMIN or 23646
Change:	(6 characters)

8. Log Defaults (p. 6)

Reset all logs	
Space/Log:	

9. Call Services

(pp. 6, 7, 9)

Auto Call Info	Show line: _
Auto Call Info	None
Set services	Show set: _
Autolog/ShowVMsg	For each line assigned: Y N
Logging set:	Y N
Show extl VMsg:	Y N
Log space	
Log:	0
Pool:	160
Log passwd:	None
1stDisplay:	Name
	Numbr Line
VMsg centr tel#s	
VMsg center 1 to	
VMsgcenter 5:	None
VMsg tel#s-> lines	
Show line: _	
VMsg Centr:	1
	2 3 4 5 N

C. Set copy

Copy: SYSTEM data	
Copy: SYSTEM + USER	

D. System Version

SP: XXXXXXXX DRX
